

RESIDENTIAL STEEL BEAM AND COLUMN LOAD/SPAN TABLES RG-936

# technical data



**Steel Beam and  
Column Tables**

## RESIDENTIAL STEEL BEAM AND COLUMN LOAD/SPAN TABLES

PUBLICATION RG-936  
JUNE 1993

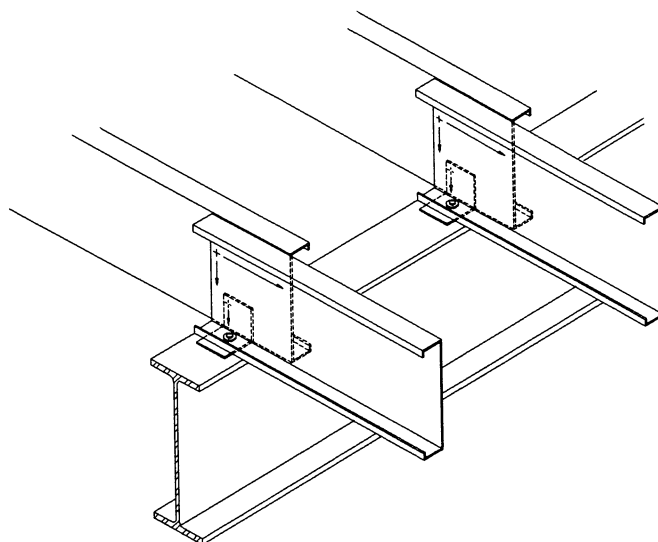

**Steel in Residential  
Construction Advisory Group**

American Iron and Steel Institute  
1101 17th Street, NW  
Washington, DC 20036-4700

**Residential Steel Beam and Column Load/Span Tables**

**American Iron and Steel Institute  
1101 17th Street, N.W., Suite 1300  
Washington, D.C. 20036-4700**

The information presented in this publication has been prepared in accordance with recognized engineering principles and is for general information only. While it is believed to be accurate, this information in it should not be used without first securing competent advice with respect to its suitability for any given application. The publication of the information is not intended as a representation or warranty on the part of American Iron and Steel Institute, the AISI Residential Advisory Group or any other person that the information is suitable for any general or particular use or is free from infringement of any patent or patents. Anyone making use of the information assumes all liability arising from such use.

Residential Steel Beam and Column Load/Span Tables  
June 1993



Copyright 1993 by American Iron and Steel Institute



## INTRODUCTION

These tables were developed by the American Iron and Steel Institute with guidance from the AISI Residential Advisory Group. They are intended to provide designers and contractors with guidance on design of low-rise residential buildings that utilize steel structural members. AISI believes that the information contained in these tables substantially represents industry practice and related scientific and technical information, but the information is not intended to represent an official position of AISI or to restrict or exclude any other construction or design techniques. Additional design and detailing is required to incorporate these components into construction.

The American Institute of Steel Construction Specification for Structural Steel Buildings, dated June 1989 and Manual of Steel Construction, Allowable Stress Design, dated 1989 were used as the standards for the development of these tables. They are referenced throughout this publication and should be considered an integral part of structural steel design.

American Iron and Steel Institute  
June 1993

## TABLE OF CONTENTS

---

<b>Subject</b>		<b>Page</b>
Discussion and Examples.....		i
Center Beam Tables	One Supported Floor.....	1
	Two Supported Floors.....	4
	Three Supported Floors.....	7
Column Tables	One Supported Floor.....	10
	Two Supported Floors.....	11
	Three Supported Floors.....	14

---





## Residential Steel Beam and Column Load/Span Tables

### DISCUSSION

These load/span tables include beam and column sections that are commonly used in residential construction. The tables are based on information contained in the 1989 American Institute of Steel Construction (AISC), Allowable Stress Design, Specification and Manual and contain beams and columns supporting floor system spans or tributary widths ranging from 6 to 24 feet (in two foot increments).

A floor live load of 40 pounds per square foot (psf) on the first supported level and 30 psf on any additional levels was used in developing these tables for one, two and three supported floors. The tables include floor system dead loads of 10, 15 and 20 psf to account for various finishes or superimposed loads. The weight of the steel beams has been included in the calculations. In addition, the weight of the interior bearing wall supporting the second and third floors (as applicable) has been included. Roof system loads are not included. It is assumed that the roof system spans between exterior bearing walls. If the roof system is supported by the interior bearing walls and the roof loads do not exceed the floor loads used in the tables, the tables can be used assuming that the roof is considered an additional supported floor.

### Beam Tables

Beam designs are based on single (simple) span conditions. This approach will provide some conservatism for multiple (continuous) spans. These spans are generally controlled by allowable moment capacities, but in some cases are limited so as not to exceed a live load deflection limit of  $L/360$ . In the case of continuous beams, spans limited by live load deflection will be somewhat conservative.

The tabulated beam span values are also based on a minimum of  $1\frac{3}{4}$  inches of bearing along the axis of the beam at each beam end and  $3\frac{1}{2}$  inches at each column where beams are continuous over the column. In some cases beam spans have been limited in order to

maintain these bearing requirements. A bearing width perpendicular to the beam axis (in addition to the beam flange width) may also be required when the beam is supported on materials other than steel. Information on bearing plates and column cap and base plates is not included in the scope of these tables. Guidance on the design of beam and column bearings can be found in Part 2 and 3 of the AISC Manual.

Interpolation between values is not recommended since calculations are not linear. It is suggested that actual tributary widths be rounded-up to the next larger tabulated tributary width, when they fall between the tabulated dimensions. Beam spans should be measured from centerline (of bearing) to centerline of support. The top flange of beams must be laterally braced at a spacing less than or equal to the unbraced length ( $L_c$ ) noted in the tables. To assure adequate bracing, members used to laterally brace the beam should be attached with fasteners that provide a positive connection.

Refer to Example 4 for guidance on the conversion of steel yield stresses for beams from 36 to 50 ksi. One of the advantages of 50 ksi steel is the added strength that is provided without the need to increase the beam size. This benefit is usually not as significant for spans controlled by deflection.

### Column Tables

The column tables should not be used for the design of columns that change in section profile between the top plate and base plate, such as screw-jack or adjustable height columns. These columns are generally proprietary and require testing to establish load carrying capabilities. The manufacturer should be contacted for design capacities if these columns.

The column spacing dimensions listed in the column tables have been calculated assuming that the eccentricity of the total or resultant load is 1 inch or less from the column centerline. This eccentricity is provided to account for some moment induced into the column through minor eccentricities in beam bearing.



# Steel Beam and Column Tables

Eccentricities can exist as a result of connection detailing, unequal beam spans on each side of the column, and unequal (pattern) loads on each side of the column. These considerations occur most frequently with single span beam conditions and are demonstrated in Example 2. For continuous beams with concentric column bearing the tabulated values may be fairly conservative. Guidance on the design of columns with

moments or eccentricities that are beyond the scope of these tables can be found in Part 3 of the AISC Manual.

The tables also assume that the columns are laterally braced at 8 feet above the slab on grade or base of the column, and should provide conservative results for columns less than 8 feet in height.

## EXAMPLE 1

Determine the required center beam and column size for a two story house (two supported floors). See the plans for overall dimensions and spans. The local building code provisions require a floor live load of 40 pounds per square foot (psf) for dwelling units (except sleeping areas) and 30 psf for sleeping areas. The unbraced height of the column is 8 feet from the top of the slab-on-grade to the beam above. The roof is composed of single span trusses. The continuous beam applies concentric loads to the columns. Dead load (weight) of the floor system is as follows:

<u>Floor Dead Load</u>	
Wood flooring	2.5
Subflooring	2.0
10" Steel Joists @ 24"	1.5
1/2" Gypsum Wallboard Ceiling	2.0
Misc. & Mech.	<u>2.0</u>
	10.0 psf

<u>Interior Bearing Wall Dead Load</u>	
3-5/8" Steel Studs @ 24"x 8'	5.0
Top & Bot. Track	2.0
1/2" Gypsum Wallboard (ea. side) x 8'	<u>32.0</u>
	39.0 plf

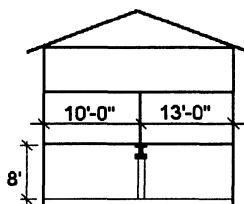
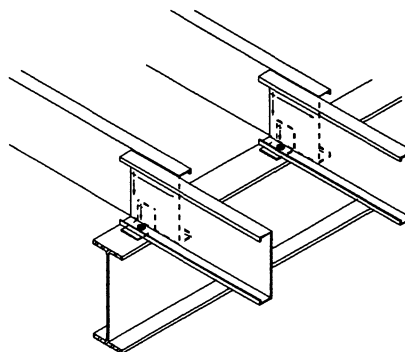
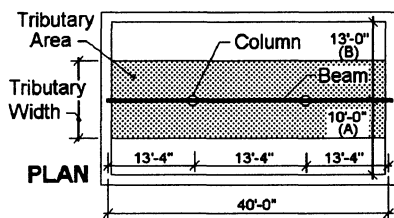

**Solution:** One continuous beam with two columns equally spaced is chosen. The top flange of the beam is to be braced at each joist (a positive connection is necessary between each joist and the beam). Provide a minimum of 1¾ inches of bearing at the beam ends and 3½ inches of bearing at each column.



**Beam Design:** Unbraced length = 2' < L<sub>c</sub>: *ok, joists are connected to the beam with anchor clips.*  
 Tributary width = (A+B)/2 = (13+10)/2 = 11'-6": *Round up to 12'-0".*  
 DL = 10 psf: *Use the table on page 4.*  
 DL wall < 50 plf: *ok*  
 L = 13'-4": *Using the table on page 4, enter the column for the Tributary Width = 12'-0". Follow down the column until the values exceed 13.33 feet. A W8x18 or a W10x15 are the first beams that exceed the span requirements (14.5 and 13.8, respectively). If headroom is limited the W8x18 could be specified, but for greater economy the W10x15 will be used. USE W10x15*

Check beam bearing plate requirements per the AISC Specification, since the ends will be supported on a concrete wall. Guidance on bearing design can be found on pages 2-31 and 2-141 through 2-144 of the 1989 AISC ASD Manual. Reactions may be determined as follows:

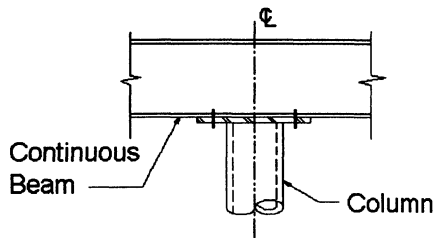

$$\text{Simple beam loads} = 13.33[11.5(10+10+40+30) + 39 + 15] = 14,516 \text{ lbs.}$$

$$\text{Simple beam end reaction} = (14,516)/2 = 7,258 \text{ lbs.}$$

Adjust reactions to account for a continuous (one piece) beam. Using the coefficients on page 2-312 (3-span condition) of the AISC Manual:

$$\text{Continuous Beam Reaction at Exterior Supports} = 14,516(4/10) = 5,806 \text{ lbs.}$$

$$\text{Continuous Beam Reaction at Interior Supports} = 14,516[(6+5)/10] = 15,968 \text{ lbs.}$$

**Column Design:** Unbraced Length ≤ 8': *ok*  
 Tributary width = (A+B)/2 = (13+10)/2 = 11'-6": *Round up to 12'-0".*  
 DL = 10 psf: *Use the table on page 11.*  
 DL wall < 50 plf: *ok*  
 L = 13'-4": *Using the table on page 11, enter the column for the Tributary Width Supported by the Beam = 12'-0". Follow down the column until the values exceed 13.33 feet. This occurs with a 3" diameter Standard (STD.) pipe column (13.6 feet). USE 3" dia. STD. Pipe*

Since the beam is continuous no further adjustments are necessary. The reactions calculated above for a continuous beam may be used to design for the cap and base plate requirements of the column. Guidance on base plate design can be found on pages 3-106 through 3-111 of the 1989 AISC ASD Manual.

## EXAMPLE 2

Use Example 1 except add a thick set tile floor to the system and use only one column. Increase the dead load to 20 psf to account for the tile flooring. The span of the beams is 20 feet.

**Solution:** Due to the possible weight of the steel beam and difficulties in handling during erection two single span beams will be used.

**Beam Design:** Unbraced length = 2' < L<sub>c</sub>: *ok*  
 (A+B)/2 = (13+10)/2 = 11'-6": *Round up to 12'-0".*  
 DL = 20 psf: *Use the table on page 6.*  
 DL wall < 50 plf: *ok*  
 L = 20'-0": *Using the table on page 6, enter the column for the Tributary Width Supported by the Beam = 12'-0". Follow down the column until the values exceed 20.0 feet. A W14x26 is the first beam that equals the span requirements (20.0 feet). USE 2 ea. W14x26*





# Steel Beam and Column Tables

Provide a minimum of 1¼ inches of bearing at beam ends. Check beam bearing plate requirements per the AISC Specification, since the ends will be supported on a concrete wall.

Simple beam loads =  $20.0[11.5(20+20+40+30) + 39 + 26] = 26,600$  lbs.  
Simple beam end reaction =  $(26,600)/2 = 13,300$  lbs.

Column Design: Unbraced Length ≤ 8': *ok*

$(A+B)/2 = (13+10)/2 = 11'-6"$ : *Round up to 12'-0"*.

DL = 20 psf: *Use the table on page 13.*

DL wall < 50 plf: *ok*

L = 20'-0": *Using the table on page 13, enter the column for the Tributary Width Supported by the Beam = 12'-0". Follow down the column until the values exceed 20.0 feet. This occurs with a TS 4x4x0.1875 tube column or a 4" diameter Standard (STD.) pipe column. The TS 4x4 weighs less.*

**USE TS 4x4x0.1875" dia. Tube Column**

The reactions calculated above may be used to design for the bearing requirements of the column.

Check load eccentricity: (For larger eccentric loading conditions refer to the AISC Specification Chapters E and H and Part 3 of the AISC Manual).

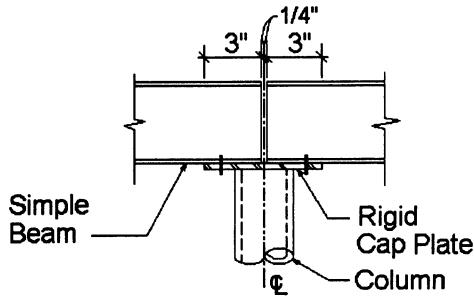

Each beam end is ¼ inch from the column centerline and the bearing length is 3 inches. Therefore the eccentricity for each beam reaction is ¼ + 3/2 = 1¾ inches (dimension from the centerline of bearing to the centerline of the column). Under full load the eccentric loads counteract each other and do not induce any moment into the column. The maximum unbalanced load condition occurs when all the live load is on one beam. Therefore this case has to be checked.

Total load for unbalanced case =  $20.0[11.5(20+20) + 39 + 26] + 10.0[11.5(40+30)] = 18,550$  lbs.  
Unbalanced load (live load) =  $10[11.5(40+30)] = 8,050$  lbs.  
Eccentricity of the total load =  $8,050(1.75)/18,550 = 0.76$  inches < 1 inch: *ok*

### EXAMPLE 3

The builder has requested that the beam sizes for a housing development be kept the same to simplify ordering and stocking. W8x15 was previously specified. The overall plan of the home is 34 feet by 36 feet. It has two supported floors. The floor spans in the 34 foot direction. The roof is single span trusses. Dead load is 15 psf. The wall dead load is 40 plf. The beams are to be continuous and adequate bearing will be provided. The continuous beams provide concentric loading on the columns.

#### Solution:

Beam Design: Unbraced length = 2' < L<sub>c</sub>: *ok*

$(A+B)/2 = 34/2 = 17'-0"$ : *Round up to 18'-0"*.

or use two rows of beams,  $34/3 = 11'-4"$ : *Round up to 12'-0"*.

DL = 15 psf: *Use the table on page 5.*

DL wall < 50 plf: *ok*

W8x15 for the 18'-0" floor span: *From the table on page 5 the maximum span is 10.0 feet.*

W8x15 for the 12'-0" floor span: *From the table on page 5 the maximum span is 12.2 feet.*



**Column Design:** For the 18'-0" floor span and 10.0 foot beam span:

*From the table on page 12 a 3.5" dia. STD. pipe column is ok (11.5 feet).*

For the 12'-0" floor span and 12.2 foot beam span: *From the table on page 12 a 3" dia. STD. pipe column is ok (12.3 feet).*

There are two options available. The first is to provide one beam line (17'-0" floor span) with three interior columns at 9 feet on center. The second option is to have two beam lines (11'-4" floor spans) with two rows of two interior columns at 12 feet on center. Although the first option utilizes less structural steel, the benefits of larger column spacings and shorter floor spans should be considered.

## EXAMPLE 4

For greater economy utilize steel beams with a yield stress of 50 ksi for Example 1. Again, headroom is not a concern.

**Solution:** Since a W8x18 and a W10x15 meet the design criteria for  $F_y = 36$  ksi, the first trial size for a 50 ksi steel will be a W8x15 and a W10x12 (by inspection the next smaller size will not work).

$$L_{c-50} = L_{c-36}(36/50)$$

$$L_{50} = L_{36}(50/36)^{1/2}$$

Check Deflection

$$L_{LL-50} = L_{LL-36}/(S_R/S_{LL})^{1/3}$$

$$\text{For W8x15 } L_{c-50} = 4.2(36/50) = 3.0 \text{ feet} > 2 \text{ feet: } \textit{ok}$$

$$\text{For W10x12 } L_{c-50} = 3.9(36/50) = 2.8 \text{ feet} > 2 \text{ feet: } \textit{ok}$$

$$\text{For W8x15 } L_{50} = 12.8(50/36)^{1/2} = 15.1 \text{ feet: } \textit{ok}$$

$$\text{For W10x12 } L_{50} = 12.3(50/36)^{1/2} = 14.5 \text{ feet: } \textit{ok}$$

$L_{LL-36}$  = Maximum span where live load deflection first controlled the design (at any tributary width,  $(A+B)/2$ ).

$S_R = (A+B)/2$  required the actual case.

$S_{LL} = (A+B)/2$  for the first case that is controlled by live load deflection.

For W8x15  $L_{LL-50} = 15.4/(12/8)^{1/3} = 13.5$  feet  $< 15.0$ : *Deflection controls, but it does exceed the required 13'-4" span.*

For W10x12, no  $L_{LL-36}$  is tabulated: *Calculate the deflection as follows:*

$$\begin{aligned} \Delta_{LL} &= 5wL^4/384(EI) \leq L/360 = 13.33(12)/360 = 0.44" \\ &= 5[11.5(40+30)/1000](13.33)^4(1728)/384(29000)(53.8) \\ &= 0.37" < 0.44": \textit{ok} \end{aligned}$$

Check bearing

$$RE_{50} = RE_{36}(50/36)^{1/2}$$

$$RI_{50} = RI_{36}(50/36)^{1/2}$$

Since the RE and RI values for the W10x12 are less than the values for the W8x15, check only the W10x12. See Example 1 for reactions.

$$RE_{50} = 11(50/36)^{1/2} = 12.96 \text{ kips} > 5,806 \text{ lbs or } 5.8 \text{ kips: } \textit{ok}$$

$$RI_{50} = 29(50/36)^{1/2} = 34.18 \text{ kips} > 15,968 \text{ lbs or } 15.97 \text{ kips: } \textit{ok}$$

**USE W10x12,  $F_y = 50$  ksi**





## Residential Steel Beam Load/Span Tables - Wide Flange Beams

### MAXIMUM SPAN FOR CENTER BEAMS SUPPORTING ONE FLOOR ONLY (no roof or attic loads) - L

DL (psf)\* 10  
LL (psf)\* 40

BEAM PROPERTIES (Min. Fy = 36ksi)							TRIBUTARY WIDTH SUPPORTED BY THE CENTER BEAM - (A+B)/2									
SIZE	I	S	Mc	Lc	RE	RI	6'-0	8'-0	10'-0	12'-0	14'-0	16'-0	18'-0	20'-0	22'-0	24'-0
W6x9	16.4	5.6	11.0	4.2	11	26	14.3 LL	13.0 LL	12.0 LL	11.3 LL	10.8 LL	10.3 LL	9.8 Mc	9.3 Mc	8.9 Mc	8.5 Mc
W6x12	22.1	7.3	14.5	4.2	18	36	15.8 LL	14.3 LL	13.3 LL	12.5 LL	11.9 LL	11.4 LL	10.9 LL	10.6 LL	10.2 Mc	9.8 Mc
W8x10	30.8	7.8	15.5	4.2	10	26	17.6 LL	16.0 LL	14.9 LL	14.0 LL	13.2 Mc	12.4 Mc	11.7 Mc	11.1 Mc	10.6 Mc	10.1 Mc
W6x16	32.1	10.2	20.2	4.3	22	45	17.9 LL	16.2 LL	15.1 LL	14.2 LL	13.5 LL	12.9 LL	12.4 LL	12.0 LL	11.6 LL	11.3 LL
W8x13	39.6	9.9	19.6	4.2	18	38	19.2 LL	17.4 LL	16.2 LL	15.2 LL	14.4 LL	13.8 LL	13.1 Mc	12.4 Mc	11.9 Mc	11.4 Mc
W8x15	48.0	11.8	23.4	4.2	20	42	20.4 LL	18.6 LL	17.2 LL	16.2 LL	15.4 LL	14.7 LL	14.2 LL	13.6 Mc	12.9 Mc	12.4 Mc
W10x12	53.8	10.9	21.6	3.9	11	29	21.2 LL	19.3 LL	17.9 LL	16.8 Mc	15.6 Mc	14.6 Mc	13.8 Mc	13.1 Mc	12.5 Mc	11.9 Mc
W8x18	61.9	15.2	30.1	5.5	18	40	22.2 LL	20.2 LL	18.7 LL	17.6 LL	16.8 LL	16.0 LL	15.4 LL	14.9 LL	14.4 LL	14.0 LL
W10x15	68.9	13.8	27.3	4.2	17	38	23.0 LL	20.9 LL	19.4 LL	18.3 LL	17.4 LL	16.4 Mc	15.5 Mc	14.7 Mc	14.0 Mc	13.4 Mc
W8x21	75.3	18.2	36.0	5.6	21	45	23.7 LL	21.6 LL	20.0 LL	18.8 LL	17.9 LL	17.1 LL	16.5 LL	15.9 LL	15.4 LL	15.0 LL
W10x17	81.9	16.2	32.1	4.2	18	41	24.4 LL	22.2 LL	20.6 LL	19.4 LL	18.4 LL	17.6 LL	16.7 Mc	15.9 Mc	15.2 Mc	14.5 Mc
W8x24	82.8	20.9	41.4	6.9	21	46	24.5 LL	22.2 LL	20.7 LL	19.4 LL	18.5 LL	17.7 LL	17.0 LL	16.4 LL	15.9 LL	15.4 LL
W12x14	88.6	14.9	29.5	3.5	12	30	25.0 LL	22.8 LL	21.1 LL	19.6 Mc	18.2 Mc	17.0 Mc	16.1 Mc	15.3 Mc	14.6 Mc	13.9 Mc
W10x19	96.3	18.8	37.2	4.2	20	45	25.7 LL	23.4 LL	21.7 LL	20.4 LL	19.4 LL	18.6 LL	17.9 LL	17.1 Mc	16.3 Mc	15.6 Mc
W8x28	98.0	24.3	48.1	6.9	28	55	25.9 LL	23.5 LL	21.8 LL	20.6 LL	19.5 LL	18.7 LL	18.0 LL	17.3 LL	16.8 LL	16.3 LL
W12x16	103.0	17.1	33.9	4.1	14	36	26.3 LL	23.9 LL	22.2 LL	20.9 LL	19.4 Mc	18.2 Mc	17.2 Mc	16.3 Mc	15.6 Mc	14.9 Mc
W10x22	118.0	23.2	45.9	6.1	18	41	27.6 LL	25.0 LL	23.2 LL	21.9 LL	20.8 LL	19.9 LL	19.1 LL	18.5 LL	17.9 LL	17.3 Mc
W12x19	130.0	21.3	42.2	4.2	17	40	28.5 LL	25.9 LL	24.0 LL	22.6 LL	21.5 LL	20.3 Mc	19.2 Mc	18.2 Mc	17.4 Mc	16.6 Mc
W10x26	144.0	27.9	55.2	6.1	22	49	29.4 LL	26.8 LL	24.8 LL	23.4 LL	22.2 LL	21.2 LL	20.4 LL	19.7 LL	19.1 LL	18.6 LL
W12x22	156.0	25.4	50.3	4.3	21	49	30.2 LL	27.5 LL	25.5 LL	24.0 LL	22.8 LL	21.8 LL	20.9 Mc	19.8 Mc	18.9 Mc	18.1 Mc
W10x30	170.0	32.4	64.2	6.1	29	58	31.1 LL	28.3 LL	26.2 LL	24.7 LL	23.5 LL	22.4 LL	21.6 LL	20.8 LL	20.2 LL	19.6 LL
W14x22	199.0	29.0	57.4	5.3	16	37	32.8 LL	29.8 LL	27.7 LL	26.0 LL	24.7 LL	23.6 Mc	22.3 Mc	21.2 Mc	20.2 Mc	19.4 Mc
W14x26	245.0	35.3	69.9	5.3	20	46	35.1 LL	31.9 LL	29.6 LL	27.9 LL	26.5 LL	25.3 LL	24.4 LL	23.3 Mc	22.3 Mc	21.4 Mc

L = Span from center to center of supports, ft. L must be >= dimension C, D, or E, whichever applies for single span beams. Base size of a continuous beam on the maximum of C, D, or E.

I = Moment of Inertia, in.<sup>4</sup> S = Elastic Section Modulus, in.<sup>3</sup> Member Properties per the 1989 AISC ASD Manual.

Mc = Allowable moment assuming Fb = 0.66Fy in accordance with the 1989 AISC ASD Specification, k-ft.

Lc = Maximum unbraced length of the beam in order to use this table and Mc, ft.

RE = Max. beam end reaction for 1-3/4" bearing, kips. RI = Continuous beam max. reaction at interior supports with 3-1/2" bearing, kips.

\* No live load reductions have been included. + DL is in addition to beam weight.

Span dimensions are governed as noted by either moment capacity (Mc), live load deflection of L/360 (LL), or interior (RI) or exterior (RE) bearing requirements.

Greater bearing dimensions are usually required for beams on non-steel supports. Guidance on bearing design can be found on pages 2-141 through 2-144 of the 1989 AISC ASD Manual.

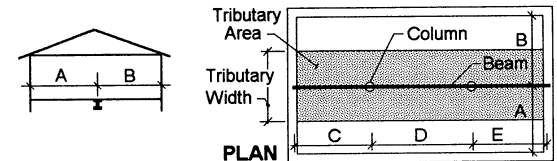



## Residential Steel Beam Load/Span Tables - Wide Flange Beams

### MAXIMUM SPAN FOR CENTER BEAMS SUPPORTING ONE FLOOR ONLY (no roof or attic loads) - L

DL (psf)\* 15  
LL (psf)\* 40

BEAM PROPERTIES (Min. Fy = 36ksi)							TRIBUTARY WIDTH SUPPORTED BY THE CENTER BEAM - (A+B)/2													
SIZE	I	S	Mc	Lc	RE	RI	6'-0	8'-0	10'-0	12'-0	14'-0	16'-0	18'-0	20'-0	22'-0	24'-0				
W6x9	16.4	5.6	11.0	4.2	11	26	14.3 LL	13.0 LL	12.0 LL	11.3 LL	10.6 Mc	10.0 Mc	9.4 Mc	8.9 Mc	8.5 Mc	8.1 Mc				
W6x12	22.1	7.3	14.5	4.2	18	36	15.8 LL	14.3 LL	13.3 LL	12.5 LL	11.9 LL	11.4 LL	10.7 Mc	10.2 Mc	9.7 Mc	9.3 Mc				
W8x10	30.8	7.8	15.5	4.2	10	26	17.6 LL	16.0 LL	14.9 LL	13.6 Mc	12.6 Mc	11.8 Mc	11.1 Mc	10.6 Mc	10.1 Mc	9.6 Mc				
W6x16	32.1	10.2	20.2	4.3	22	45	17.9 LL	16.2 LL	15.1 LL	14.2 LL	13.5 LL	12.9 LL	12.4 LL	12.0 LL	11.5 Mc	11.0 Mc				
W8x13	39.6	9.9	19.6	4.2	18	38	19.2 LL	17.4 LL	16.2 LL	15.2 LL	14.2 Mc	13.3 Mc	12.5 Mc	11.9 Mc	11.3 Mc	10.9 Mc				
W8x15	48.0	11.8	23.4	4.2	20	42	20.4 LL	18.6 LL	17.2 LL	16.2 LL	15.4 LL	14.5 Mc	13.6 Mc	12.9 Mc	12.4 Mc	11.8 Mc				
W10x12	53.8	10.9	21.6	3.9	11	29	21.2 LL	19.3 LL	17.5 Mc	16.0 Mc	14.9 Mc	13.9 Mc	13.1 Mc	12.5 Mc	11.9 Mc	11.4 Mc				
W8x18	61.9	15.2	30.1	5.5	18	40	22.2 LL	20.2 LL	18.7 LL	17.6 LL	16.8 LL	16.0 LL	15.4 LL	14.7 Mc	14.0 Mc	13.4 Mc				
W10x15	68.9	13.8	27.3	4.2	17	38	23.0 LL	20.9 LL	19.4 LL	18.0 Mc	16.7 Mc	15.6 Mc	14.7 Mc	14.0 Mc	13.4 Mc	12.8 Mc				
W8x21	75.3	18.2	36.0	5.6	21	45	23.7 LL	21.6 LL	20.0 LL	18.8 LL	17.9 LL	17.1 LL	16.5 LL	15.9 LL	15.3 Mc	14.7 Mc				
W10x17	81.9	16.2	32.1	4.2	18	41	24.4 LL	22.2 LL	20.6 LL	19.4 LL	18.1 Mc	16.9 Mc	16.0 Mc	15.2 Mc	14.5 Mc	13.9 Mc				
W8x24	82.8	20.9	41.4	6.9	21	46	24.5 LL	22.2 LL	20.7 LL	19.4 LL	18.5 LL	17.7 LL	17.0 LL	16.4 LL	15.9 LL	15.4 LL				
W12x14	88.6	14.9	29.5	3.5	12	30	25.0 LL	22.8 LL	20.5 Mc	18.7 Mc	17.4 Mc	16.2 Mc	15.3 Mc	14.6 Mc	13.9 Mc	13.3 Mc				
W10x19	96.3	18.8	37.2	4.2	20	45	25.7 LL	23.4 LL	21.7 LL	20.4 LL	19.4 LL	18.2 Mc	17.2 Mc	16.3 Mc	15.6 Mc	14.9 Mc				
W8x28	98.0	24.3	48.1	6.9	28	55	25.9 LL	23.5 LL	21.8 LL	20.6 LL	19.5 LL	18.7 LL	18.0 LL	17.3 LL	16.8 LL	16.3 LL				
W12x16	103.0	17.1	33.9	4.1	14	36	26.3 LL	23.9 LL	21.9 Mc	20.0 Mc	18.6 Mc	17.4 Mc	16.4 Mc	15.6 Mc	14.9 Mc	14.2 Mc				
W10x22	118.0	23.2	45.9	6.1	18	41	27.6 LL	25.0 LL	23.2 LL	21.9 LL	20.8 LL	19.9 LL	19.1 Mc	18.1 Mc	17.3 Mc	16.5 Mc				
W12x19	130.0	21.3	42.2	4.2	17	40	28.5 LL	25.9 LL	24.0 LL	22.3 Mc	20.7 Mc	19.4 Mc	18.3 Mc	17.4 Mc	16.6 Mc	15.9 Mc				
W10x26	144.0	27.9	55.2	6.1	22	49	29.4 LL	26.8 LL	24.8 LL	23.4 LL	22.2 LL	21.2 LL	20.4 LL	19.7 LL	18.9 Mc	18.1 Mc				
W12x22	156.0	25.4	50.3	4.3	21	49	30.2 LL	27.5 LL	25.5 LL	24.0 LL	22.5 Mc	21.1 Mc	19.9 Mc	18.9 Mc	18.1 Mc	17.3 Mc				
W10x30	170.0	32.4	64.2	6.1	29	58	31.1 LL	28.3 LL	26.2 LL	24.7 LL	23.5 LL	22.4 LL	21.6 LL	20.8 LL	20.2 LL	19.5 Mc				
W14x22	199.0	29.0	57.4	5.3	16	37	32.8 LL	29.8 LL	27.7 LL	26.0 Mc	24.1 Mc	22.6 Mc	21.3 Mc	20.2 Mc	19.3 Mc	18.5 Mc				
W14x26	245.0	35.3	69.9	5.3	20	46	35.1 LL	31.9 LL	29.6 LL	27.9 LL	26.5 LL	24.8 Mc	23.5 Mc	22.3 Mc	21.3 Mc	20.4 Mc				

L = Span from center to center of supports, ft. L must be >= dimension C, D, or E, whichever applies for single span beams. Base size of a continuous beam on the maximum of C, D, or E.

I = Moment of Inertia, in.<sup>4</sup> S = Elastic Section Modulus, in.<sup>3</sup> Member Properties per the 1989 AISC ASD Manual.

Mc = Allowable moment assuming Fb = 0.66Fy in accordance with the 1989 AISC ASD Specification, k-ft.

Lc = Maximum unbraced length of the beam in order to use this table and Mc, ft.

RE = Max. beam end reaction for 1-3/4" bearing, kips. RI = Continuous beam max. reaction at interior supports with 3-1/2" bearing, kips.

\* No live load reductions have been included. + DL is in addition to beam weight.

Span dimensions are governed as noted by either moment capacity (Mc), live load deflection of L/360 (LL), or interior (RI) or exterior (RE) bearing requirements.

Greater bearing dimensions are usually required for beams on non-steel supports. Guidance on bearing design can be found on pages 2-141 through 2-144 of the 1989 AISC ASD Manual.

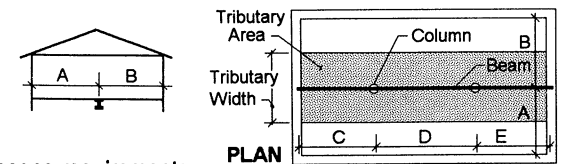



## Residential Steel Beam Load/Span Tables - Wide Flange Beams

### MAXIMUM SPAN FOR CENTER BEAMS SUPPORTING ONE FLOOR ONLY (no roof or attic loads) - L

DL (psf)\* 20  
LL (psf)\* 40

BEAM PROPERTIES (Min. Fy = 36ksi)							TRIBUTARY WIDTH SUPPORTED BY THE CENTER BEAM - (A+B)/2													
SIZE	I	S	Mc	Lc	RE	RI	6'-0"	8'-0"	10'-0"	12'-0"	14'-0"	16'-0"	18'-0"	20'-0"	22'-0"	24'-0"				
W6x9	16.4	5.6	11.0	4.2	11	26	14.3 LL	13.0 LL	12.0 Mc	11.0 Mc	10.2 Mc	9.5 Mc	9.0 Mc	8.5 Mc	8.1 Mc	7.8 Mc				
W6x12	22.1	7.3	14.5	4.2	18	36	15.8 LL	14.3 LL	13.3 LL	12.5 LL	11.7 Mc	10.9 Mc	10.3 Mc	9.8 Mc	9.3 Mc	8.9 Mc				
W8x10	30.8	7.8	15.5	4.2	10	26	17.6 LL	15.9 Mc	14.2 Mc	13.0 Mc	12.1 Mc	11.3 Mc	10.7 Mc	10.1 Mc	9.6 Mc	9.2 Mc				
W6x16	32.1	10.2	20.2	4.3	22	45	17.9 LL	16.2 LL	15.1 LL	14.2 LL	13.5 LL	12.9 Mc	12.1 Mc	11.5 Mc	11.0 Mc	10.5 Mc				
W8x13	39.6	9.9	19.6	4.2	18	38	19.2 LL	17.4 LL	16.0 Mc	14.6 Mc	13.6 Mc	12.7 Mc	12.0 Mc	11.4 Mc	10.9 Mc	10.4 Mc				
W8x15	48.0	11.8	23.4	4.2	20	42	20.4 LL	18.6 LL	17.2 LL	15.9 Mc	14.8 Mc	13.8 Mc	13.1 Mc	12.4 Mc	11.8 Mc	11.3 Mc				
W10x12	53.8	10.9	21.6	3.9	11	29	21.2 LL	18.7 Mc	16.8 Mc	15.4 Mc	14.2 Mc	13.3 Mc	12.6 Mc	11.9 Mc	11.4 Mc	10.9 Mc				
W8x18	61.9	15.2	30.1	5.5	18	40	22.2 LL	20.2 LL	18.7 LL	17.6 LL	16.8 Mc	15.7 Mc	14.8 Mc	14.1 Mc	13.4 Mc	12.9 Mc				
W10x15	68.9	13.8	27.3	4.2	17	38	23.0 LL	20.9 LL	18.9 Mc	17.2 Mc	16.0 Mc	15.0 Mc	14.1 Mc	13.4 Mc	12.8 Mc	12.3 Mc				
W8x21	75.3	18.2	36.0	5.6	21	45	23.7 LL	21.6 LL	20.0 LL	18.8 LL	17.9 LL	17.1 LL	16.2 Mc	15.4 Mc	14.7 Mc	14.0 Mc				
W10x17	81.9	16.2	32.1	4.2	18	41	24.4 LL	22.2 LL	20.4 Mc	18.7 Mc	17.3 Mc	16.2 Mc	15.3 Mc	14.5 Mc	13.9 Mc	13.3 Mc				
W8x24	82.8	20.9	41.4	6.9	21	46	24.5 LL	22.2 LL	20.7 LL	19.4 LL	18.5 LL	17.7 LL	17.0 LL	16.4 LL	15.7 Mc	15.0 Mc				
W12x14	88.6	14.9	29.5	3.5	12	30	25.0 LL	21.9 Mc	19.6 Mc	17.9 Mc	16.6 Mc	15.6 Mc	14.7 Mc	13.9 Mc	13.3 Mc	12.7 Mc				
W10x19	96.3	18.8	37.2	4.2	20	45	25.7 LL	23.4 LL	21.7 LL	20.1 Mc	18.6 Mc	17.4 Mc	16.5 Mc	15.6 Mc	14.9 Mc	14.3 Mc				
W8x28	98.0	24.3	48.1	6.9	28	55	25.9 LL	23.5 LL	21.8 LL	20.6 LL	19.5 LL	18.7 LL	18.0 LL	17.3 LL	16.8 LL	16.2 Mc				
W12x16	103.0	17.1	33.9	4.1	14	36	26.3 LL	23.4 Mc	21.0 Mc	19.2 Mc	17.8 Mc	16.7 Mc	15.7 Mc	14.9 Mc	14.2 Mc	13.6 Mc				
W10x22	118.0	23.2	45.9	6.1	18	41	27.6 LL	25.0 LL	23.2 LL	21.9 LL	20.6 Mc	19.3 Mc	18.3 Mc	17.3 Mc	16.5 Mc	15.9 Mc				
W12x19	130.0	21.3	42.2	4.2	17	40	28.5 LL	25.9 LL	23.3 Mc	21.4 Mc	19.8 Mc	18.6 Mc	17.5 Mc	16.6 Mc	15.9 Mc	15.2 Mc				
W10x26	144.0	27.9	55.2	6.1	22	49	29.4 LL	26.8 LL	24.8 LL	23.4 LL	22.2 LL	21.2 Mc	20.0 Mc	19.0 Mc	18.1 Mc	17.4 Mc				
W12x22	156.0	25.4	50.3	4.3	21	49	30.2 LL	27.5 LL	25.4 Mc	23.3 Mc	21.6 Mc	20.2 Mc	19.1 Mc	18.1 Mc	17.3 Mc	16.6 Mc				
W10x30	170.0	32.4	64.2	6.1	29	58	31.1 LL	28.3 LL	26.2 LL	24.7 LL	23.5 LL	22.4 LL	21.5 Mc	20.4 Mc	19.5 Mc	18.7 Mc				
W14x22	199.0	29.0	57.4	5.3	16	37	32.8 LL	29.8 LL	27.2 Mc	24.9 Mc	23.1 Mc	21.6 Mc	20.4 Mc	19.4 Mc	18.5 Mc	17.7 Mc				
W14x26	245.0	35.3	69.9	5.3	20	46	35.1 LL	31.9 LL	29.6 LL	27.4 Mc	25.4 Mc	23.8 Mc	22.5 Mc	21.4 Mc	20.4 Mc	19.5 Mc				

L = Span from center to center of supports, ft. L must be > = dimension C, D, or E, whichever applies for single span beams. Base size of a continuous beam on the maximum of C, D, or E.

I = Moment of Inertia, in.<sup>4</sup> S = Elastic Section Modulus, in.<sup>3</sup> Member Properties per the 1989 AISC ASD Manual.

Mc = Allowable moment assuming Fb = 0.66Fy in accordance with the 1989 AISC ASD Specification, k-ft.

Lc = Maximum unbraced length of the beam in order to use this table and Mc, ft.

RE = Max. beam end reaction for 1-3/4" bearing, kips. RI = Continuous beam max. reaction at interior supports with 3-1/2" bearing, kips.

\* No live load reductions have been included. + DL is in addition to beam weight.

Span dimensions are governed as noted by either moment capacity (Mc), live load deflection of L/360 (LL), or interior (RI) or exterior (RE) bearing requirements.

Greater bearing dimensions are usually required for beams on non-steel supports. Guidance on bearing design can be found on pages 2-141 through 2-144 of the 1989 AISC ASD Manual.

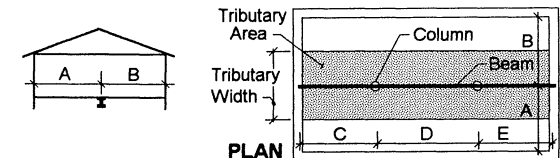





BEAM PROPERTIES (Min. Fy = 36ksi)							TRIBUTARY WIDTH SUPPORTED BY THE CENTER BEAM - (A+B)/2																							
							6'-0"	8'-0"	10'-0"	12'-0"	14'-0"	16'-0"	18'-0"	20'-0"	22'-0"	24'-0"	DL (psf) +	1st Flr	10	2nd flr	10									
<b>MAXIMUM SPAN FOR CENTER BEAMS SUPPORTING TWO FLOORS (no roof or attic loads) - L</b>														LL (psf)*							1st Flr		40		2nd flr		30			
SIZE	I	S	Mc	Lc	RE	RI	6'-0"	8'-0"	10'-0"	12'-0"	14'-0"	16'-0"	18'-0"	20'-0"	22'-0"	24'-0"														
W6x9	16.4	5.6	11.0	4.2	11	26	11.9 LL	10.6 Mc	9.6 Mc	8.8 Mc	8.2 Mc	7.7 Mc	7.2 Mc	6.9 Mc	6.6 Mc	6.3 Mc														
W6x12	22.1	7.3	14.5	4.2	18	36	13.1 LL	11.9 LL	11.0 Mc	10.1 Mc	9.4 Mc	8.8 Mc	8.3 Mc	7.9 Mc	7.5 Mc	7.2 Mc														
W8x10	30.8	7.8	15.5	4.2	10	26	14.4 Mc	12.6 Mc	11.4 Mc	10.4 Mc	9.7 Mc	9.1 Mc	8.6 Mc	8.2 Mc	7.8 Mc	7.5 Mc														
W6x16	32.1	10.2	20.2	4.3	22	45	14.8 LL	13.5 LL	12.5 LL	11.8 LL	11.0 Mc	10.4 Mc	9.8 Mc	9.3 Mc	8.9 Mc	8.5 Mc														
W8x13	39.6	9.9	19.6	4.2	18	38	15.9 LL	14.2 Mc	12.8 Mc	11.7 Mc	10.9 Mc	10.2 Mc	9.7 Mc	9.2 Mc	8.8 Mc	8.4 Mc														
W8x15	48.0	11.8	23.4	4.2	20	42	16.9 LL	15.4 LL	13.9 Mc	12.8 Mc	11.9 Mc	11.1 Mc	10.5 Mc	10.0 Mc	9.6 Mc	9.2 Mc														
W10x12	53.8	10.9	21.6	3.9	11	29	16.9 Mc	14.9 Mc	13.4 Mc	12.3 Mc	11.4 Mc	10.7 Mc	10.1 Mc	9.6 Mc	9.2 Mc	8.8 Mc														
W8x18	61.9	15.2	30.1	5.5	18	40	18.4 LL	16.8 LL	15.6 LL	14.5 Mc	13.5 Mc	12.6 Mc	11.9 Mc	11.4 Mc	10.8 Mc	10.4 Mc														
W10x15	68.9	13.8	27.3	4.2	17	38	19.0 Mc	16.7 Mc	15.1 Mc	13.8 Mc	12.8 Mc	12.1 Mc	11.4 Mc	10.8 Mc	10.3 Mc	9.9 Mc														
W8x21	75.3	18.2	36.0	5.6	21	45	19.7 LL	17.9 LL	16.6 LL	15.6 LL	14.7 Mc	13.8 Mc	13.1 Mc	12.4 Mc	11.9 Mc	11.4 Mc														
W10x17	81.9	16.2	32.1	4.2	18	41	20.2 LL	18.1 Mc	16.3 Mc	15.0 Mc	13.9 Mc	13.0 Mc	12.3 Mc	11.7 Mc	11.2 Mc	10.7 Mc														
W8x24	82.8	20.9	41.4	6.9	21	46	20.3 LL	18.5 LL	17.1 LL	16.1 LL	15.3 LL	14.7 LL	14.0 Mc	13.3 Mc	12.7 Mc	12.2 Mc														
W12x14	88.6	14.9	29.5	3.5	12	30	19.8 Mc	17.4 Mc	15.6 Mc	14.4 Mc	13.4 Mc	12.5 Mc	11.8 Mc	11.3 Mc	10.7 Mc	10.3 Mc														
W10x19	96.3	18.8	37.2	4.2	20	45	21.4 LL	19.4 LL	17.5 Mc	16.1 Mc	15.0 Mc	14.0 Mc	13.3 Mc	12.6 Mc	12.1 Mc	11.6 Mc														
W8x28	98.0	24.3	48.1	6.9	28	55	21.5 LL	19.5 LL	18.1 LL	17.1 LL	16.2 LL	15.5 LL	14.9 LL	14.3 Mc	13.7 Mc	13.1 Mc														
W12x16	103.0	17.1	33.9	4.1	14	36	21.1 Mc	18.6 Mc	16.7 Mc	15.4 Mc	14.3 Mc	13.4 Mc	12.7 Mc	12.0 Mc	11.5 Mc	11.0 Mc														
W10x22	118.0	23.2	45.9	6.1	18	41	22.9 LL	20.8 LL	19.3 LL	17.9 Mc	16.6 Mc	15.6 Mc	14.7 Mc	14.0 Mc	13.4 Mc	12.8 Mc														
W12x19	130.0	21.3	42.2	4.2	17	40	23.5 Mc	20.7 Mc	18.7 Mc	17.1 Mc	15.9 Mc	15.0 Mc	14.1 Mc	13.4 Mc	12.8 Mc	12.3 Mc														
W10x26	144.0	27.9	55.2	6.1	22	49	24.4 LL	22.2 LL	20.6 LL	19.4 LL	18.2 Mc	17.1 Mc	16.1 Mc	15.3 Mc	14.7 Mc	14.1 Mc														
W12x22	156.0	25.4	50.3	4.3	21	49	25.1 LL	22.5 Mc	20.3 Mc	18.7 Mc	17.4 Mc	16.3 Mc	15.4 Mc	14.7 Mc	14.0 Mc	13.4 Mc														
W10x30	170.0	32.4	64.2	6.1	29	58	25.8 LL	23.5 LL	21.8 LL	20.5 LL	19.5 LL	18.4 Mc	17.4 Mc	16.5 Mc	15.8 Mc	15.1 Mc														
W14x22	199.0	29.0	57.4	5.3	16	37	27.2 LL	24.1 Mc	21.7 Mc	20.0 Mc	18.6 Mc	17.4 Mc	16.5 Mc	15.7 Mc	14.4 RI	13.3 RI														
W14x26	245.0	35.3	69.9	5.3	20	46	29.2 LL	26.5 LL	23.9 Mc	22.0 Mc	20.5 Mc	19.2 Mc	18.2 Mc	17.3 Mc	16.5 Mc	15.8 Mc														

L = Span from center to center of supports, ft. L must be >= dimension C, D, or E, whichever applies for single span beams. Base size of a continuous beam on the maximum of C, D, or E.

I = Moment of Inertia, in.<sup>4</sup> S = Elastic Section Modulus, in.<sup>3</sup> Member Properties per the 1989 AISC ASD Manual.

Mc = Allowable moment assuming Fb = 0.66Fy in accordance with the 1989 AISC ASD Specification, k-ft.

Lc = Maximum unbraced length of the beam in order to use this table and Mc, ft.

RE = Max. beam end reaction for 1-3/4" bearing, kips. RI = Continuous beam max. reaction at interior supports with 3-1/2" bearing, kips.

\* No live load reductions have been included. + DL is in addition to beam weight & 50plf for the interior walls.

Span dimensions are governed as noted by either moment capacity (Mc), live load deflection of L/360 (LL), or interior (RI) or exterior (RE) bearing requirements.

Greater bearing dimensions are usually required for beams on non-steel supports. Guidance on bearing design can be found on pages 2-141 through 2-144 of the 1989 AISC ASD Manual.

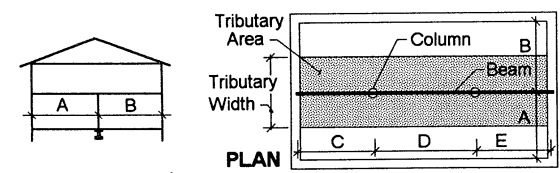



# Steel Beam and Column Tables

Copyright 1993 by American Iron and Steel Institute

## Residential Steel Beam Load/Span Tables - Wide Flange Beams

**MAXIMUM SPAN FOR CENTER BEAMS SUPPORTING TWO FLOORS (no roof or attic loads) - L**

DL (psf) +	1st flr	15	2nd flr	15
LL (psf) *	1st flr	40	2nd flr	30

BEAM PROPERTIES (Min. Fy = 36ksi)							TRIBUTARY WIDTH SUPPORTED BY THE CENTER BEAM - (A+B)/2																			
SIZE	I	S	Mc	Lc	RE	RI	6'-0"		8'-0"		10'-0"		12'-0"		14'-0"		16'-0"		18'-0"		20'-0"		22'-0"		24'-0"	
W6x9	16.4	5.6	11.0	4.2	11	26	11.6	Mc	10.1	Mc	9.1	Mc	8.4	Mc	7.8	Mc	7.3	Mc	6.9	Mc	6.5	Mc	6.2	Mc	6.0	Mc
W6x12	22.1	7.3	14.5	4.2	18	36	13.1	LL	11.6	Mc	10.4	Mc	9.6	Mc	8.9	Mc	8.3	Mc	7.9	Mc	7.5	Mc	7.2	Mc	6.9	Mc
W8x10	30.8	7.8	15.5	4.2	10	26	13.7	Mc	12.0	Mc	10.8	Mc	9.9	Mc	9.2	Mc	8.6	Mc	8.2	Mc	7.7	Mc	7.4	Mc	7.1	Mc
W6x16	32.1	10.2	20.2	4.3	22	45	14.8	LL	13.5	LL	12.3	Mc	11.3	Mc	10.5	Mc	9.8	Mc	9.3	Mc	8.8	Mc	8.4	Mc	8.1	Mc
W8x13	39.6	9.9	19.6	4.2	18	38	15.4	Mc	13.5	Mc	12.2	Mc	11.1	Mc	10.4	Mc	9.7	Mc	9.2	Mc	8.7	Mc	8.3	Mc	8.0	Mc
W8x15	48.0	11.8	23.4	4.2	20	42	16.8	Mc	14.7	Mc	13.2	Mc	12.2	Mc	11.3	Mc	10.6	Mc	10.0	Mc	9.5	Mc	9.1	Mc	8.7	Mc
W10x12	53.8	10.9	21.6	3.9	11	29	16.1	Mc	14.2	Mc	12.8	Mc	11.7	Mc	10.9	Mc	10.2	Mc	9.6	Mc	9.2	Mc	8.7	Mc	8.4	Mc
W8x18	61.9	15.2	30.1	5.5	18	40	18.4	LL	16.7	Mc	15.0	Mc	13.8	Mc	12.8	Mc	12.0	Mc	11.4	Mc	10.8	Mc	10.3	Mc	9.9	Mc
W10x15	68.9	13.8	27.3	4.2	17	38	18.1	Mc	15.9	Mc	14.3	Mc	13.1	Mc	12.2	Mc	11.5	Mc	10.8	Mc	10.3	Mc	9.8	Mc	9.4	Mc
W8x21	75.3	18.2	36.0	5.6	21	45	19.7	LL	17.9	LL	16.4	Mc	15.1	Mc	14.0	Mc	13.1	Mc	12.4	Mc	11.8	Mc	11.3	Mc	10.8	Mc
W10x17	81.9	16.2	32.1	4.2	18	41	19.6	Mc	17.2	Mc	15.5	Mc	14.2	Mc	13.2	Mc	12.4	Mc	11.7	Mc	11.1	Mc	10.6	Mc	10.2	Mc
W8x24	82.8	20.9	41.4	6.9	21	46	20.3	LL	18.5	LL	17.1	LL	16.1	Mc	15.0	Mc	14.1	Mc	13.3	Mc	12.6	Mc	12.1	Mc	11.6	Mc
W12x14	88.6	14.9	29.5	3.5	12	30	18.9	Mc	16.5	Mc	14.9	Mc	13.7	Mc	12.7	Mc	11.9	Mc	11.3	Mc	10.7	Mc	10.2	Mc	9.6	RE
W10x19	96.3	18.8	37.2	4.2	20	45	21.1	Mc	18.5	Mc	16.7	Mc	15.3	Mc	14.2	Mc	13.4	Mc	12.6	Mc	12.0	Mc	11.5	Mc	11.0	Mc
W8x28	98.0	24.3	48.1	6.9	28	55	21.5	LL	19.5	LL	18.1	LL	17.1	LL	16.1	Mc	15.1	Mc	14.3	Mc	13.6	Mc	13.0	Mc	12.5	Mc
W12x16	103.0	17.1	33.9	4.1	14	36	20.2	Mc	17.7	Mc	15.9	Mc	14.6	Mc	13.6	Mc	12.8	Mc	12.0	Mc	11.5	Mc	10.9	Mc	10.5	Mc
W10x22	118.0	23.2	45.9	6.1	18	41	22.9	LL	20.5	Mc	18.5	Mc	17.0	Mc	15.8	Mc	14.8	Mc	14.0	Mc	13.3	Mc	12.7	Mc	12.2	Mc
W12x19	130.0	21.3	42.2	4.2	17	40	22.5	Mc	19.7	Mc	17.8	Mc	16.3	Mc	15.2	Mc	14.2	Mc	13.4	Mc	12.8	Mc	12.2	Mc	11.7	Mc
W10x26	144.0	27.9	55.2	6.1	22	49	24.4	LL	22.2	LL	20.3	Mc	18.6	Mc	17.3	Mc	16.2	Mc	15.3	Mc	14.6	Mc	13.9	Mc	13.4	Mc
W12x22	156.0	25.4	50.3	4.3	21	49	24.5	Mc	21.5	Mc	19.4	Mc	17.8	Mc	16.5	Mc	15.5	Mc	14.7	Mc	13.9	Mc	13.3	Mc	12.8	Mc
W10x30	170.0	32.4	64.2	6.1	29	58	25.8	LL	23.5	LL	21.8	LL	20.0	Mc	18.6	Mc	17.5	Mc	16.5	Mc	15.7	Mc	15.0	Mc	14.4	Mc
W14x22	199.0	29.0	57.4	5.3	16	37	26.1	Mc	23.0	Mc	20.7	Mc	19.0	Mc	17.7	Mc	16.6	Mc	15.7	Mc	14.3	RI	13.0	RI	12.0	RI
W14x26	245.0	35.3	69.9	5.3	20	46	28.8	Mc	25.3	Mc	22.8	Mc	20.9	Mc	19.5	Mc	18.3	Mc	17.3	Mc	16.4	Mc	15.7	Mc	14.8	RI

L = Span from center to center of supports, ft. L must be >= dimension C, D, or E, whichever applies for single span beams. Base size of a continuous beam on the maximum of C, D, or E.

I = Moment of Inertia, in.<sup>4</sup> S = Elastic Section Modulus, in.<sup>3</sup> Member Properties per the 1989 AISC ASD Manual.

Mc = Allowable moment assuming Fb = 0.66Fy in accordance with the 1989 AISC ASD Specification, k-ft.

Lc = Maximum unbraced length of the beam in order to use this table and Mc, ft.

RE = Max. beam end reaction for 1-3/4" bearing, kips. RI = Continuous beam max. reaction at interior supports with 3-1/2" bearing, kips.

\* No live load reductions have been included. + DL is in addition to beam weight & 50plf for the interior walls.

Span dimensions are governed as noted by either moment capacity (Mc), live load deflection of L/360 (LL), or interior (RI) or exterior (RE) bearing requirements.

Greater bearing dimensions are usually required for beams on non-steel supports. Guidance on bearing design can be found on pages 2-141 through 2-144 of the 1989 AISC ASD Manual.

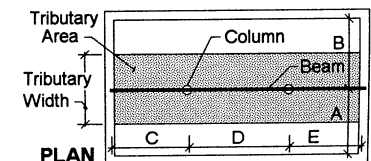
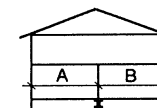





# Steel Beam and Column Tables

Copyright 1993 by American Iron and Steel Institute

BEAM PROPERTIES (Min. Fy = 36ksi)							TRIBUTARY WIDTH SUPPORTED BY THE CENTER BEAM - (A+B)/2																			
							DL (psf)*		1st Flr		20		2nd flr		20		LL (psf)*		1st Flr		40		2nd flr		30	
SIZE	I	S	Mc	Lc	RE	RI	6'-0	8'-0	10'-0	12'-0	14'-0	16'-0	18'-0	20'-0	22'-0	24'-0	6'-0	8'-0	10'-0	12'-0	14'-0	16'-0	18'-0	20'-0	22'-0	24'-0
W6x9	16.4	5.6	11.0	4.2	11	26	11.1 Mc	9.7 Mc	8.7 Mc	8.0 Mc	7.4 Mc	7.0 Mc	6.6 Mc	6.2 Mc	6.0 Mc	5.7 Mc	11.1 Mc	9.7 Mc	8.7 Mc	8.0 Mc	7.4 Mc	7.0 Mc	6.6 Mc	6.2 Mc	6.0 Mc	5.7 Mc
W6x12	22.1	7.3	14.5	4.2	18	36	12.7 Mc	11.1 Mc	10.0 Mc	9.2 Mc	8.5 Mc	8.0 Mc	7.5 Mc	7.2 Mc	6.8 Mc	6.5 Mc	12.7 Mc	11.1 Mc	10.0 Mc	9.2 Mc	8.5 Mc	8.0 Mc	7.5 Mc	7.2 Mc	6.8 Mc	6.5 Mc
W8x10	30.8	7.8	15.5	4.2	10	26	13.1 Mc	11.5 Mc	10.3 Mc	9.5 Mc	8.8 Mc	8.2 Mc	7.8 Mc	7.4 Mc	7.1 Mc	6.8 Mc	13.1 Mc	11.5 Mc	10.3 Mc	9.5 Mc	8.8 Mc	8.2 Mc	7.8 Mc	7.4 Mc	7.1 Mc	6.8 Mc
W6x16	32.1	10.2	20.2	4.3	22	45	14.8 LL	13.1 Mc	11.8 Mc	10.8 Mc	10.0 Mc	9.4 Mc	8.9 Mc	8.4 Mc	8.1 Mc	7.7 Mc	14.8 LL	13.1 Mc	11.8 Mc	10.8 Mc	10.0 Mc	9.4 Mc	8.9 Mc	8.4 Mc	8.1 Mc	7.7 Mc
W8x13	39.6	9.9	19.6	4.2	18	38	14.7 Mc	12.9 Mc	11.6 Mc	10.7 Mc	9.9 Mc	9.3 Mc	8.8 Mc	8.3 Mc	8.0 Mc	7.6 Mc	14.7 Mc	12.9 Mc	11.6 Mc	10.7 Mc	9.9 Mc	9.3 Mc	8.8 Mc	8.3 Mc	8.0 Mc	7.6 Mc
W8x15	48.0	11.8	23.4	4.2	20	42	16.1 Mc	14.1 Mc	12.7 Mc	11.6 Mc	10.8 Mc	10.1 Mc	9.6 Mc	9.1 Mc	8.7 Mc	8.3 Mc	16.1 Mc	14.1 Mc	12.7 Mc	11.6 Mc	10.8 Mc	10.1 Mc	9.6 Mc	9.1 Mc	8.7 Mc	8.3 Mc
W10x12	53.8	10.9	21.6	3.9	11	29	15.5 Mc	13.5 Mc	12.2 Mc	11.2 Mc	10.4 Mc	9.7 Mc	9.2 Mc	8.7 Mc	8.3 Mc	8.0 Mc	15.5 Mc	13.5 Mc	12.2 Mc	11.2 Mc	10.4 Mc	9.7 Mc	9.2 Mc	8.7 Mc	8.3 Mc	8.0 Mc
W8x18	61.9	15.2	30.1	5.5	18	40	18.2 Mc	15.9 Mc	14.4 Mc	13.2 Mc	12.2 Mc	11.5 Mc	10.8 Mc	10.3 Mc	9.8 Mc	9.4 Mc	18.2 Mc	15.9 Mc	14.4 Mc	13.2 Mc	12.2 Mc	11.5 Mc	10.8 Mc	10.3 Mc	9.8 Mc	9.4 Mc
W10x15	68.9	13.8	27.3	4.2	17	38	17.4 Mc	15.2 Mc	13.7 Mc	12.6 Mc	11.7 Mc	10.9 Mc	10.3 Mc	9.8 Mc	9.4 Mc	9.0 Mc	17.4 Mc	15.2 Mc	13.7 Mc	12.6 Mc	11.7 Mc	10.9 Mc	10.3 Mc	9.8 Mc	9.4 Mc	9.0 Mc
W8x21	75.3	18.2	36.0	5.6	21	45	19.7 LL	17.4 Mc	15.7 Mc	14.4 Mc	13.4 Mc	12.5 Mc	11.9 Mc	11.3 Mc	10.8 Mc	10.3 Mc	19.7 LL	17.4 Mc	15.7 Mc	14.4 Mc	13.4 Mc	12.5 Mc	11.9 Mc	11.3 Mc	10.8 Mc	10.3 Mc
W10x17	81.9	16.2	32.1	4.2	18	41	18.8 Mc	16.5 Mc	14.8 Mc	13.6 Mc	12.6 Mc	11.9 Mc	11.2 Mc	10.6 Mc	10.2 Mc	9.7 Mc	18.8 Mc	16.5 Mc	14.8 Mc	13.6 Mc	12.6 Mc	11.9 Mc	11.2 Mc	10.6 Mc	10.2 Mc	9.7 Mc
W8x24	82.8	20.9	41.4	6.9	21	46	20.3 LL	18.5 LL	16.8 Mc	15.4 Mc	14.3 Mc	13.4 Mc	12.7 Mc	12.1 Mc	11.5 Mc	11.0 Mc	20.3 LL	18.5 LL	16.8 Mc	15.4 Mc	14.3 Mc	13.4 Mc	12.7 Mc	12.1 Mc	11.5 Mc	11.0 Mc
W12x14	88.6	14.9	29.5	3.5	12	30	18.1 Mc	15.8 Mc	14.2 Mc	13.1 Mc	12.1 Mc	11.4 Mc	10.7 Mc	10.2 Mc	9.5 RE	8.8 RE	18.1 Mc	15.8 Mc	14.2 Mc	13.1 Mc	12.1 Mc	11.4 Mc	10.7 Mc	10.2 Mc	9.5 RE	8.8 RE
W10x19	96.3	18.8	37.2	4.2	20	45	20.2 Mc	17.7 Mc	16.0 Mc	14.6 Mc	13.6 Mc	12.8 Mc	12.1 Mc	11.5 Mc	10.9 Mc	10.5 Mc	20.2 Mc	17.7 Mc	16.0 Mc	14.6 Mc	13.6 Mc	12.8 Mc	12.1 Mc	11.5 Mc	10.9 Mc	10.5 Mc
W8x28	98.0	24.3	48.1	6.9	28	55	21.5 LL	19.5 LL	18.1 Mc	16.6 Mc	15.4 Mc	14.5 Mc	13.7 Mc	13.0 Mc	12.4 Mc	11.9 Mc	21.5 LL	19.5 LL	18.1 Mc	16.6 Mc	15.4 Mc	14.5 Mc	13.7 Mc	13.0 Mc	12.4 Mc	11.9 Mc
W12x16	103.0	17.1	33.9	4.1	14	36	19.3 Mc	16.9 Mc	15.2 Mc	14.0 Mc	13.0 Mc	12.2 Mc	11.5 Mc	10.9 Mc	10.4 Mc	10.0 Mc	19.3 Mc	16.9 Mc	15.2 Mc	14.0 Mc	13.0 Mc	12.2 Mc	11.5 Mc	10.9 Mc	10.4 Mc	10.0 Mc
W10x22	118.0	23.2	45.9	6.1	18	41	22.4 Mc	19.6 Mc	17.7 Mc	16.2 Mc	15.1 Mc	14.2 Mc	13.4 Mc	12.7 Mc	12.1 Mc	11.6 Mc	22.4 Mc	19.6 Mc	17.7 Mc	16.2 Mc	15.1 Mc	14.2 Mc	13.4 Mc	12.7 Mc	12.1 Mc	11.6 Mc
W12x19	130.0	21.3	42.2	4.2	17	40	21.5 Mc	18.9 Mc	17.0 Mc	15.6 Mc	14.5 Mc	13.6 Mc	12.8 Mc	12.2 Mc	11.6 Mc	11.2 Mc	21.5 Mc	18.9 Mc	17.0 Mc	15.6 Mc	14.5 Mc	13.6 Mc	12.8 Mc	12.2 Mc	11.6 Mc	11.2 Mc
W10x26	144.0	27.9	55.2	6.1	22	49	24.4 LL	21.5 Mc	19.4 Mc	17.8 Mc	16.5 Mc	15.5 Mc	14.7 Mc	13.9 Mc	13.3 Mc	12.8 Mc	24.4 LL	21.5 Mc	19.4 Mc	17.8 Mc	16.5 Mc	15.5 Mc	14.7 Mc	13.9 Mc	13.3 Mc	12.8 Mc
W12x22	156.0	25.4	50.3	4.3	21	49	23.4 Mc	20.6 Mc	18.5 Mc	17.0 Mc	15.8 Mc	14.8 Mc	14.0 Mc	13.3 Mc	12.7 Mc	12.2 Mc	23.4 Mc	20.6 Mc	18.5 Mc	17.0 Mc	15.8 Mc	14.8 Mc	14.0 Mc	13.3 Mc	12.7 Mc	12.2 Mc
W10x30	170.0	32.4	64.2	6.1	29	58	25.8 LL	23.1 Mc	20.9 Mc	19.1 Mc	17.8 Mc	16.7 Mc	15.8 Mc	15.0 Mc	14.3 Mc	13.7 Mc	25.8 LL	23.1 Mc	20.9 Mc	19.1 Mc	17.8 Mc	16.7 Mc	15.8 Mc	15.0 Mc	14.3 Mc	13.7 Mc
W14x22	199.0	29.0	57.4	5.3	16	37	25.1 Mc	22.0 Mc	19.8 Mc	18.2 Mc	16.9 Mc	15.8 Mc	14.4 RI	13.0 RI	11.9 RI	10.9 RI	25.1 Mc	22.0 Mc	19.8 Mc	18.2 Mc	16.9 Mc	15.8 Mc	14.4 RI	13.0 RI	11.9 RI	10.9 RI
W14x26	245.0	35.3	69.9	5.3	20	46	27.6 Mc	24.2 Mc	21.8 Mc	20.0 Mc	18.6 Mc	17.5 Mc	16.5 Mc	15.7 Mc	14.7 RI	13.5 RI	27.6 Mc	24.2 Mc	21.8 Mc	20.0 Mc	18.6 Mc	17.5 Mc	16.5 Mc	15.7 Mc	14.7 RI	13.5 RI

L = Span from center to center of supports, ft. L must be > = dimension C, D, or E, whichever applies for single span beams. Base size of a continuous beam on the maximum of C, D, or E.

I = Moment of Inertia, in<sup>4</sup> S = Elastic Section Modulus, in<sup>3</sup> Member Properties per the 1989 AISC ASD Manual.

Mc = Allowable moment assuming Fb = 0.66Fy in accordance with the 1989 AISC ASD Specification, k-ft.

Lc = Maximum unbraced length of the beam in order to use this table and Mc, ft.

RE = Max. beam end reaction for 1-3/4" bearing, kips. RI = Continuous beam max. reaction at interior supports with 3-1/2" bearing, kips.

\* No live load reductions have been included. + DL is in addition to beam weight & 50plf for the interior walls.

Span dimensions are governed as noted by either moment capacity (Mc), live load deflection of L/360 (LL), or interior (RI) or exterior (RE) bearing requirements.

Greater bearing dimensions are usually required for beams on non-steel supports. Guidance on bearing design can be found on pages 2-141 through 2-144 of the 1989 AISC ASD Manual.

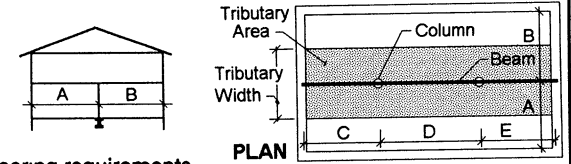



## Residential Steel Beam Load/Span Tables - Wide Flange Beams

**MAXIMUM SPAN FOR CENTER BEAMS SUPPORTING THREE FLOORS (no roof or attic loads) - L**

<b>DL (psf)*</b>	<b>1st Flr</b>	<b>10</b>	<b>2, 3 Flrs</b>	<b>10</b>
<b>LL (psf)*</b>	<b>1st Flr</b>	<b>40</b>	<b>2, 3 Flrs</b>	<b>30</b>

BEAM PROPERTIES (Min. Fy = 36ksi)							TRIBUTARY WIDTH SUPPORTED BY THE CENTER BEAM - (A+B)/2													
SIZE	I	S	Mc	Lc	RE	RI	6'-0	8'-0	10'-0	12'-0	14'-0	16'-0	18'-0	20'-0	22'-0	24'-0				
W6x9	16.4	5.6	11.0	4.2	11	26	10.0 Mc	8.8 Mc	7.9 Mc	7.3 Mc	6.8 Mc	6.3 Mc	6.0 Mc	5.7 Mc	5.4 Mc	5.2 Mc				
W6x12	22.1	7.3	14.5	4.2	18	36	11.4 Mc	10.0 Mc	9.1 Mc	8.3 Mc	7.7 Mc	7.3 Mc	6.9 Mc	6.5 Mc	6.2 Mc	6.0 Mc				
W8x10	30.8	7.8	15.5	4.2	10	26	11.8 Mc	10.4 Mc	9.4 Mc	8.6 Mc	8.0 Mc	7.5 Mc	7.1 Mc	6.8 Mc	6.5 Mc	6.0 RE				
W6x16	32.1	10.2	20.2	4.3	22	45	13.2 LL	11.8 Mc	10.7 Mc	9.8 Mc	9.1 Mc	8.6 Mc	8.1 Mc	7.7 Mc	7.4 Mc	7.1 Mc				
W8x13	39.6	9.9	19.6	4.2	18	38	13.3 Mc	11.7 Mc	10.5 Mc	9.7 Mc	9.0 Mc	8.5 Mc	8.0 Mc	7.6 Mc	7.3 Mc	7.0 Mc				
W8x15	48.0	11.8	23.4	4.2	20	42	14.5 Mc	12.7 Mc	11.5 Mc	10.6 Mc	9.8 Mc	9.2 Mc	8.7 Mc	8.3 Mc	7.9 Mc	7.6 Mc				
W10x12	53.8	10.9	21.6	3.9	11	29	13.9 Mc	12.2 Mc	11.1 Mc	10.2 Mc	9.5 Mc	8.9 Mc	8.4 Mc	8.0 Mc	7.6 RE	7.0 RE				
W8x18	61.9	15.2	30.1	5.5	18	40	16.4 Mc	14.4 Mc	13.0 Mc	12.0 Mc	11.1 Mc	10.5 Mc	9.9 Mc	9.4 Mc	9.0 Mc	8.6 Mc				
W10x15	68.9	13.8	27.3	4.2	17	38	15.6 Mc	13.8 Mc	12.4 Mc	11.4 Mc	10.6 Mc	10.0 Mc	9.4 Mc	9.0 Mc	8.6 Mc	8.2 Mc				
W8x21	75.3	18.2	36.0	5.6	21	45	17.5 LL	15.8 Mc	14.2 Mc	13.1 Mc	12.2 Mc	11.4 Mc	10.8 Mc	10.3 Mc	9.8 Mc	9.4 Mc				
W10x17	81.9	16.2	32.1	4.2	18	41	16.9 Mc	14.9 Mc	13.5 Mc	12.4 Mc	11.5 Mc	10.8 Mc	10.2 Mc	9.7 Mc	9.3 Mc	8.9 Mc				
W8x24	82.8	20.9	41.4	6.9	21	46	18.0 LL	16.4 LL	15.2 LL	14.0 Mc	13.0 Mc	12.3 Mc	11.6 Mc	11.0 Mc	10.5 Mc	10.1 Mc				
W12x14	88.6	14.9	29.5	3.5	12	30	16.2 Mc	14.3 Mc	12.9 Mc	11.9 Mc	11.0 Mc	10.4 Mc	9.7 RE	8.7 RE	8.0 RE	7.3 RE				
W10x19	96.3	18.8	37.2	4.2	20	45	18.2 Mc	16.0 Mc	14.5 Mc	13.3 Mc	12.4 Mc	11.6 Mc	11.0 Mc	10.5 Mc	10.0 Mc	9.6 Mc				
W8x28	98.0	24.3	48.1	6.9	28	55	19.1 LL	17.3 LL	16.1 LL	15.1 Mc	14.1 Mc	13.2 Mc	12.5 Mc	11.9 Mc	11.3 Mc	10.9 Mc				
W12x16	103.0	17.1	33.9	4.1	14	36	17.4 Mc	15.3 Mc	13.8 Mc	12.7 Mc	11.8 Mc	11.1 Mc	10.5 Mc	10.0 Mc	9.5 Mc	8.8 RI				
W10x22	118.0	23.2	45.9	6.1	18	41	20.2 Mc	17.8 Mc	16.1 Mc	14.8 Mc	13.8 Mc	12.9 Mc	12.2 Mc	11.6 Mc	11.1 RI	10.2 RI				
W12x19	130.0	21.3	42.2	4.2	17	40	19.4 Mc	17.1 Mc	15.4 Mc	14.2 Mc	13.2 Mc	12.4 Mc	11.7 Mc	11.1 Mc	10.6 Mc	9.9 RI				
W10x26	144.0	27.9	55.2	6.1	22	49	21.7 LL	19.5 Mc	17.6 Mc	16.2 Mc	15.1 Mc	14.2 Mc	13.4 Mc	12.7 Mc	12.2 Mc	11.7 Mc				
W12x22	156.0	25.4	50.3	4.3	21	49	21.1 Mc	18.6 Mc	16.8 Mc	15.5 Mc	14.4 Mc	13.5 Mc	12.8 Mc	12.2 Mc	11.6 Mc	11.1 Mc				
W10x30	170.0	32.4	64.2	6.1	29	58	22.9 LL	20.8 LL	18.9 Mc	17.4 Mc	16.2 Mc	15.2 Mc	14.4 Mc	13.7 Mc	13.1 Mc	12.6 Mc				
W14x22	199.0	29.0	57.4	5.3	16	37	22.6 Mc	19.9 Mc	18.0 Mc	16.5 Mc	15.3 RI	13.5 RI	12.0 RI	10.9 RI	9.9 RI	9.1 RI				
W14x26	245.0	35.3	69.9	5.3	20	46	24.8 Mc	21.9 Mc	19.8 Mc	18.2 Mc	17.0 Mc	15.9 Mc	14.9 RI	13.5 RI	12.3 RI	11.3 RI				

L = Span from center to center of supports, ft. L must be >= dimension C, D, or E, whichever applies for single span beams. Base size of a continuous beam on the maximum of C, D, or E.

I = Moment of Inertia, in.<sup>4</sup> S = Elastic Section Modulus, in.<sup>3</sup> Member Properties per the 1989 AISC ASD Manual.

Mc = Allowable moment assuming Fb = 0.66Fy in accordance with the 1989 AISC ASD Specification, k-ft.

Lc = Maximum unbraced length of the beam in order to use this table and Mc, ft.

RE = Max. beam end reaction for 1-3/4" bearing, kips. RI = Continuous beam max. reaction at interior supports with 3-1/2" bearing, kips.

\* No live load reductions have been included. + DL is in addition to beam weight & 100plf for the interior walls.

Span dimensions are governed as noted by either moment capacity (Mc), live load deflection of L/360 (LL), or interior (RI) or exterior (RE) bearing requirements.

Greater bearing dimensions are usually required for beams on non-steel supports. Guidance on bearing design can be found on pages 2-141 through 2-144 of the 1989 AISC ASD Manual.

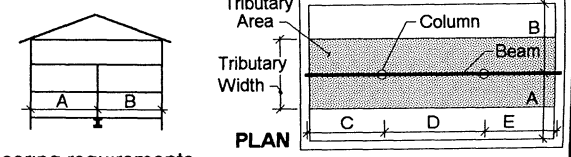



# Steel Beam and Column Tables

Copyright 1993 by American Iron and Steel Institute

BEAM PROPERTIES (Min. Fy = 36ksi)							TRIBUTARY WIDTH SUPPORTED BY THE CENTER BEAM - (A+B)/2																							
							6'-0"	8'-0"	10'-0"	12'-0"	14'-0"	16'-0"	18'-0"	20'-0"	22'-0"	24'-0"	DL (psf)*		1st Flr		2, 3 Flrs									
SIZE	I	S	Mc	Lc	RE	RI	6'-0"		8'-0"		10'-0"		12'-0"		14'-0"		16'-0"		18'-0"		20'-0"		22'-0"		24'-0"		1st Flr	15	2, 3 Flrs	15
W6x9	16.4	5.6	11.0	4.2	11	26	9.5	Mc	8.3	Mc	7.5	Mc	6.9	Mc	6.4	Mc	6.0	Mc	5.7	Mc	5.4	Mc	5.2	Mc	5.0	Mc				
W6x12	22.1	7.3	14.5	4.2	18	36	10.9	Mc	9.5	Mc	8.6	Mc	7.9	Mc	7.4	Mc	6.9	Mc	6.5	Mc	6.2	Mc	5.9	Mc	5.7	Mc				
W8x10	30.8	7.8	15.5	4.2	10	26	11.2	Mc	9.9	Mc	8.9	Mc	8.2	Mc	7.6	Mc	7.1	Mc	6.7	Mc	6.4	Mc	5.9	RE	5.4	RE				
W6x16	32.1	10.2	20.2	4.3	22	45	12.8	Mc	11.3	Mc	10.2	Mc	9.3	Mc	8.7	Mc	8.1	Mc	7.7	Mc	7.3	Mc	7.0	Mc	6.7	Mc				
W8x13	39.6	9.9	19.6	4.2	18	38	12.6	Mc	11.1	Mc	10.0	Mc	9.2	Mc	8.6	Mc	8.0	Mc	7.6	Mc	7.2	Mc	6.9	Mc	6.6	Mc				
W8x15	48.0	11.8	23.4	4.2	20	42	13.8	Mc	12.1	Mc	10.9	Mc	10.0	Mc	9.3	Mc	8.8	Mc	8.3	Mc	7.9	Mc	7.5	Mc	7.2	Mc				
W10x12	53.8	10.9	21.6	3.9	11	29	13.3	Mc	11.7	Mc	10.5	Mc	9.7	Mc	9.0	Mc	8.4	Mc	8.0	Mc	7.5	RE	6.8	RE	6.3	RE				
W8x18	61.9	15.2	30.1	5.5	18	40	15.6	Mc	13.7	Mc	12.4	Mc	11.4	Mc	10.6	Mc	9.9	Mc	9.4	Mc	8.9	Mc	8.5	Mc	8.2	Mc				
W10x15	68.9	13.8	27.3	4.2	17	38	14.9	Mc	13.1	Mc	11.8	Mc	10.9	Mc	10.1	Mc	9.5	Mc	9.0	Mc	8.5	Mc	8.1	Mc	7.8	Mc				
W8x21	75.3	18.2	36.0	5.6	21	45	17.1	Mc	15.0	Mc	13.5	Mc	12.4	Mc	11.6	Mc	10.9	Mc	10.3	Mc	9.8	Mc	9.3	Mc	8.9	Mc				
W10x17	81.9	16.2	32.1	4.2	18	41	16.1	Mc	14.2	Mc	12.8	Mc	11.8	Mc	10.9	Mc	10.3	Mc	9.7	Mc	9.2	Mc	8.8	Mc	8.4	Mc				
W8x24	82.8	20.9	41.4	6.9	21	46	18.0	LL	16.1	Mc	14.5	Mc	13.3	Mc	12.4	Mc	11.6	Mc	11.0	Mc	10.5	Mc	10.0	Mc	9.6	Mc				
W12x14	88.6	14.9	29.5	3.5	12	30	15.5	Mc	13.6	Mc	12.3	Mc	11.3	Mc	10.5	Mc	9.7	RE	8.7	RE	7.9	RE	7.2	RE	6.6	RE				
W10x19	96.3	18.8	37.2	4.2	20	45	17.4	Mc	15.3	Mc	13.8	Mc	12.7	Mc	11.8	Mc	11.0	Mc	10.4	Mc	9.9	Mc	9.5	Mc	9.1	Mc				
W8x28	98.0	24.3	48.1	6.9	28	55	19.1	LL	17.3	Mc	15.6	Mc	14.4	Mc	13.4	Mc	12.5	Mc	11.9	Mc	11.3	Mc	10.8	Mc	10.3	Mc				
W12x16	103.0	17.1	33.9	4.1	14	36	16.6	Mc	14.6	Mc	13.2	Mc	12.1	Mc	11.2	Mc	10.5	Mc	10.0	Mc	9.5	RI	8.6	RI	7.9	RI				
W10x22	118.0	23.2	45.9	6.1	18	41	19.2	Mc	16.9	Mc	15.3	Mc	14.0	Mc	13.1	Mc	12.3	Mc	11.6	Mc	10.9	RI	10.0	RI	9.2	RI				
W12x19	130.0	21.3	42.2	4.2	17	40	18.5	Mc	16.2	Mc	14.7	Mc	13.5	Mc	12.5	Mc	11.8	Mc	11.1	Mc	10.6	Mc	9.7	RI	8.9	RI				
W10x26	144.0	27.9	55.2	6.1	22	49	21.1	Mc	18.5	Mc	16.7	Mc	15.4	Mc	14.3	Mc	13.4	Mc	12.7	Mc	12.1	Mc	11.5	Mc	10.8	RI				
W12x22	156.0	25.4	50.3	4.3	21	49	20.1	Mc	17.7	Mc	16.0	Mc	14.7	Mc	13.7	Mc	12.8	Mc	12.1	Mc	11.5	Mc	11.0	Mc	10.6	Mc				
W10x30	170.0	32.4	64.2	6.1	29	58	22.7	Mc	19.9	Mc	18.0	Mc	16.6	Mc	15.4	Mc	14.5	Mc	13.7	Mc	13.0	Mc	12.4	Mc	11.9	Mc				
W14x22	199.0	29.0	57.4	5.3	16	37	21.5	Mc	18.9	Mc	17.1	Mc	15.7	Mc	13.8	RI	12.1	RI	10.9	RI	9.8	RI	9.0	RI	8.2	RI				
W14x26	245.0	35.3	69.9	5.3	20	46	23.7	Mc	20.9	Mc	18.8	Mc	17.3	Mc	16.1	Mc	15.0	RI	13.4	RI	12.1	RI	11.1	RI	10.2	RI				

L = Span from center to center of supports, ft. L must be >= dimension C, D, or E, whichever applies for single span beams. Base size of a continuous beam on the maximum of C, D, or E.  
 I = Moment of Inertia, in.<sup>4</sup> S = Elastic Section Modulus, in.<sup>3</sup> Member Properties per the 1989 AISC ASD Manual.  
 Mc = Allowable moment assuming Fb = 0.66Fy in accordance with the 1989 AISC ASD Specification, k-ft.  
 Lc = Maximum unbraced length of the beam in order to use this table and Mc, ft.  
 RE = Max. beam end reaction for 1-3/4" bearing, kips. RI = Continuous beam max. reaction at interior supports with 3-1/2" bearing, kips.  
 \* No live load reductions have been included. + DL is in addition to beam weight & 100plf for the interior walls.  
 Span dimensions are governed as noted by either moment capacity (Mc), live load deflection of L/360 (LL), or interior (RI) or exterior (RE) bearing requirements.  
 Greater bearing dimensions are usually required for beams on non-steel supports. Guidance on bearing design can be found on pages 2-141 through 2-144 of the 1989 AISC ASD Manual.

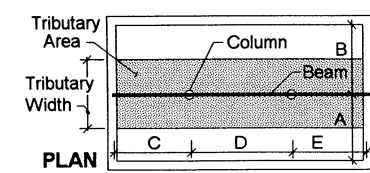
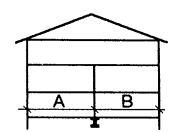



# Steel Beam and Column Tables

Copyright 1993 by American Iron and Steel Institute

## Residential Steel Beam Load/Span Tables - Wide Flange Beams MAXIMUM SPAN FOR CENTER BEAMS SUPPORTING THREE FLOORS (no roof or attic loads) - L

DL (psf)*	1st Flr	20	2, 3 Flrs	20
LL (psf)*	1st Flr	40	2, 3 Flrs	30

BEAM PROPERTIES (Min. Fy = 36ksi)							TRIBUTARY WIDTH SUPPORTED BY THE CENTER BEAM - (A+B)/2																			
SIZE	I	S	Mc	Lc	RE	RI	6'-0"		8'-0"		10'-0"		12'-0"		14'-0"		16'-0"		18'-0"		20'-0"		22'-0"		24'-0"	
W6x9	16.4	5.6	11.0	4.2	11	26	9.1	Mc	8.0	Mc	7.2	Mc	6.6	Mc	6.1	Mc	5.7	Mc	5.4	Mc	5.2	Mc	4.9	Mc	4.7	Mc
W6x12	22.1	7.3	14.5	4.2	18	36	10.4	Mc	9.1	Mc	8.2	Mc	7.5	Mc	7.0	Mc	6.6	Mc	6.2	Mc	5.9	Mc	5.6	Mc	5.4	Mc
W8x10	30.8	7.8	15.5	4.2	10	26	10.8	Mc	9.4	Mc	8.5	Mc	7.8	Mc	7.3	Mc	6.8	Mc	6.4	Mc	5.9	RE	5.4	RE	4.9	RE
W6x16	32.1	10.2	20.2	4.3	22	45	12.3	Mc	10.8	Mc	9.7	Mc	8.9	Mc	8.3	Mc	7.8	Mc	7.3	Mc	7.0	Mc	6.7	Mc	6.4	Mc
W8x13	39.6	9.9	19.6	4.2	18	38	12.1	Mc	10.6	Mc	9.6	Mc	8.8	Mc	8.2	Mc	7.7	Mc	7.2	Mc	6.9	Mc	6.6	Mc	6.3	Mc
W8x15	48.0	11.8	23.4	4.2	20	42	13.2	Mc	11.6	Mc	10.4	Mc	9.6	Mc	8.9	Mc	8.4	Mc	7.9	Mc	7.5	Mc	7.2	Mc	6.9	Mc
W10x12	53.8	10.9	21.6	3.9	11	29	12.7	Mc	11.1	Mc	10.0	Mc	9.2	Mc	8.6	Mc	8.0	Mc	7.5	RE	6.8	RE	6.2	RE	5.7	RE
W8x18	61.9	15.2	30.1	5.5	18	40	14.9	Mc	13.1	Mc	11.8	Mc	10.9	Mc	10.1	Mc	9.5	Mc	9.0	Mc	8.5	Mc	8.1	Mc	7.8	Mc
W10x15	68.9	13.8	27.3	4.2	17	38	14.3	Mc	12.5	Mc	11.3	Mc	10.4	Mc	9.6	Mc	9.0	Mc	8.5	Mc	8.1	Mc	7.8	Mc	7.4	Mc
W8x21	75.3	18.2	36.0	5.6	21	45	16.3	Mc	14.3	Mc	12.9	Mc	11.9	Mc	11.1	Mc	10.4	Mc	9.8	Mc	9.3	Mc	8.9	Mc	8.5	Mc
W10x17	81.9	16.2	32.1	4.2	18	41	15.4	Mc	13.6	Mc	12.2	Mc	11.2	Mc	10.4	Mc	9.8	Mc	9.3	Mc	8.8	Mc	8.4	Mc	8.1	Mc
W8x24	82.8	20.9	41.4	6.9	21	46	17.5	Mc	15.4	Mc	13.9	Mc	12.7	Mc	11.8	Mc	11.1	Mc	10.5	Mc	10.0	Mc	9.5	Mc	9.1	Mc
W12x14	88.6	14.9	29.5	3.5	12	30	14.8	Mc	13.0	Mc	11.7	Mc	10.8	Mc	10.0	Mc	8.9	RE	7.9	RE	7.2	RE	6.5	RE	6.0	RE
W10x19	96.3	18.8	37.2	4.2	20	45	16.6	Mc	14.6	Mc	13.2	Mc	12.1	Mc	11.2	Mc	10.5	Mc	10.0	Mc	9.5	Mc	9.0	Mc	8.7	Mc
W8x28	98.0	24.3	48.1	6.9	28	55	18.8	Mc	16.5	Mc	14.9	Mc	13.7	Mc	12.7	Mc	12.0	Mc	11.3	Mc	10.8	Mc	10.3	Mc	9.8	Mc
W12x16	103.0	17.1	33.9	4.1	14	36	15.9	Mc	13.9	Mc	12.6	Mc	11.5	Mc	10.7	Mc	10.1	Mc	9.5	Mc	8.6	RI	7.9	RI	7.2	RI
W10x22	118.0	23.2	45.9	6.1	18	41	18.4	Mc	16.2	Mc	14.6	Mc	13.4	Mc	12.5	Mc	11.7	Mc	11.0	RI	10.0	RI	9.1	RI	8.3	RI
W12x19	130.0	21.3	42.2	4.2	17	40	17.7	Mc	15.5	Mc	14.0	Mc	12.9	Mc	12.0	Mc	11.2	Mc	10.6	Mc	9.7	RI	8.8	RI	8.1	RI
W10x26	144.0	27.9	55.2	6.1	22	49	20.2	Mc	17.7	Mc	16.0	Mc	14.7	Mc	13.7	Mc	12.8	Mc	12.1	Mc	11.5	Mc	10.7	RI	9.8	RI
W12x22	156.0	25.4	50.3	4.3	21	49	19.3	Mc	16.9	Mc	15.3	Mc	14.0	Mc	13.1	Mc	12.2	Mc	11.6	Mc	11.0	Mc	10.5	Mc	9.8	RI
W10x30	170.0	32.4	64.2	6.1	29	58	21.7	Mc	19.1	Mc	17.2	Mc	15.8	Mc	14.7	Mc	13.8	Mc	13.1	Mc	12.4	Mc	11.9	Mc	11.4	Mc
W14x22	199.0	29.0	57.4	5.3	16	37	20.6	Mc	18.1	Mc	16.3	Mc	14.5	RI	12.6	RI	11.1	RI	9.9	RI	8.9	RI	8.1	RI	7.5	RI
W14x26	245.0	35.3	69.9	5.3	20	46	22.7	Mc	19.9	Mc	18.0	Mc	16.5	Mc	15.4	Mc	13.7	RI	12.2	RI	11.0	RI	10.1	RI	9.2	RI

L = Span from center to center of supports, ft. L must be >= dimension C, D, or E, whichever applies for single span beams. Base size of a continuous beam on the maximum of C, D, or E.

I = Moment of Inertia, in<sup>4</sup> S = Elastic Section Modulus, in<sup>3</sup> Member Properties per the 1989 AISC ASD Manual.

Mc = Allowable moment assuming Fb = 0.66Fy in accordance with the 1989 AISC ASD Specification, k-ft.

Lc = Maximum unbraced length of the beam in order to use this table and Mc, ft.

RE = Max. beam end reaction for 1-3/4" bearing, kips. RI = Continuous beam max. reaction at interior supports with 3-1/2" bearing, kips.

\* No live load reductions have been included.

+ DL is in addition to beam weight & 100plf for the interior walls.

Span dimensions are governed as noted by either moment capacity (Mc), live load deflection of L/360 (LL), or interior (RI) or exterior (RE) bearing requirements.

Greater bearing dimensions are usually required for beams on non-steel supports. Guidance on bearing design can be found on pages 2-141 through 2-144 of the 1989 AISC ASD Manual.

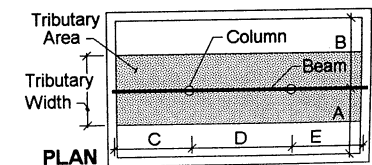
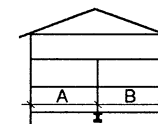





# Steel Beam and Column Tables

Copyright 1993 by American Iron and Steel Institute

## Residential Steel Column Load/Spacing Tables - Pipe and Tube Columns

MAXIMUM COLUMN SPACING, when  $C = D$  or MAXIMUM TRIBUTARY LENGTH,  $(C+D)/2$ , when  $C \neq D$ ; ft.

ONE FLOOR ONLY (no roof or attic loads) - Unbraced Length of Column = 8 feet

DL (psf) + 10  
LL (psf)\* 40

COLUMN	Column Properties					TRIBUTARY WIDTH SUPPORTED BY THE CENTER BEAM - (A+B)/2								
	SIZE	Weight/Ft.	Fy	A	Pe	Pa	8'-0	10'-0	12'-0	14'-0	16'-0	18'-0	20'-0	22'-0
3"dia. STD.	7.58	36	2.23	16	34	35.0	30.0	25.2	21.7	19.1	17.0	15.3	14.0	12.8
TS 3x3x0.1875	6.87	46	2.02	17	35	35.0	32.5	27.3	23.5	20.7	18.4	16.6	15.2	13.9
3.5"dia. STD.	9.11	36	2.68	22	44	35.0	35.0	34.6	29.8	26.2	23.4	21.1	19.2	17.7
TS 3x3x0.2500	8.81	46	2.59	21	44	35.0	35.0	33.7	29.1	25.5	22.8	20.6	18.7	17.2

DL (psf)\* 15

LL (psf)\* 40

COLUMN	Column Properties					TRIBUTARY WIDTH SUPPORTED BY THE CENTER BEAM - (A+B)/2								
	SIZE	Weight/Ft.	Fy	A	Pe	Pa	8'-0	10'-0	12'-0	14'-0	16'-0	18'-0	20'-0	22'-0
3"dia. STD.	7.58	36	2.23	16	34	33.8	27.3	23.0	19.8	17.4	15.5	14.0	12.7	11.7
TS 3x3x0.1875	6.87	46	2.02	17	35	35.0	29.6	24.9	21.4	18.8	16.8	15.2	13.8	12.7
3.5"dia. STD.	9.11	36	2.68	22	44	35.0	35.0	31.6	27.2	23.9	21.3	19.2	17.5	16.1
TS 3x3x0.2500	8.81	46	2.59	21	44	35.0	35.0	30.8	26.5	23.3	20.8	18.7	17.1	15.7

DL (psf) + 20

LL (psf)\* 40

COLUMN	Column Properties					TRIBUTARY WIDTH SUPPORTED BY THE CENTER BEAM - (A+B)/2								
	SIZE	Weight/Ft.	Fy	A	Pe	Pa	8'-0	10'-0	12'-0	14'-0	16'-0	18'-0	20'-0	22'-0
3"dia. STD.	7.58	36	2.23	16	34	31.1	25.2	21.1	18.2	16.0	14.2	12.8	11.7	10.7
TS 3x3x0.1875	6.87	46	2.02	17	35	33.8	27.3	22.9	19.7	17.3	15.4	13.9	12.7	11.6
3.5"dia. STD.	9.11	36	2.68	22	44	35.0	34.6	29.0	25.0	22.0	19.6	17.7	16.1	14.8
TS 3x3x0.2500	8.81	46	2.59	21	44	35.0	33.7	28.3	24.4	21.4	19.1	17.2	15.7	14.4

Column loads are based on a maximum eccentricity of 1" between the resultant (total) load and the centerline of the column.

Supported beams may be single span or continuous with a maximum eccentricity of 1" for the resultant load.

Fy = Minimum design yield stress per the AISC Specification, ksi. K = 1.0

A = Gross cross-sectional area of column per the AISC Manual, in.

Pe = Maximum axial load with an eccentricity of 1", per the AISC Manual, kips.

Pa = Allowable axial load values from the 1989 AISC - ASD Manual, Allowable Concentric Load Tables, kips.

\* No live load reductions have been included.

+ DL is in addition to beam weight.

$(C+D)/2$  has been limited to 35 feet to correspond with the beam tables.

Column bearing design must be per the AISC Specification. Guidance on base plate design can be found on pages 3-106 through 3-111 of the 1989 AISC ASD Manual.

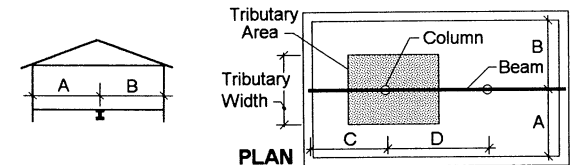



# Steel Beam and Column Tables

Copyright 1993 by American Iron and Steel Institute

Residential Steel Column Load/Spacing Tables - Pipe and Tube Columns						MAXIMUM COLUMN SPACING, when $C = D$ or MAXIMUM TRIBUTARY LENGTH, $(C+D)/2$ , when $C \neq D$ ; ft.								
TWO FLOORS (no roof or attic loads) - Unbraced Length of Column = 8 feet						DL (psf) +			1st flr 10			2nd flr 10		
						LL (psf)*			1st flr 40			2nd flr 30		
COLUMN	Column Properties					TRIBUTARY WIDTH SUPPORTED BY THE CENTER BEAM - $(A+B)/2$								
SIZE	Weight/Ft.	Fy	A	Pe	Pa	8'-0	10'-0	12'-0	14'-0	16'-0	18'-0	20'-0	22'-0	24'-0
3"dia. STD.	7.58	36	2.23	16	34	19.8	16.1	13.6	11.8	10.4	9.3	8.4	7.7	7.0
TS 3x3x0.1875	6.87	46	2.02	17	35	21.4	17.5	14.8	12.8	11.3	10.1	9.1	8.3	7.6
3.5"dia. STD.	9.11	36	2.68	22	44	27.2	22.2	18.7	16.2	14.3	12.8	11.5	10.5	9.7
TS 3x3x0.2500	8.81	46	2.59	21	44	26.5	21.6	18.2	15.8	13.9	12.4	11.2	10.3	9.4
3"dia. X-Strg.	10.25	36	3.02	20	45	25.7	20.9	17.7	15.3	13.5	12.0	10.9	9.9	9.1
TS 3x3x0.3125	10.58	46	3.11	24	51	30.3	24.7	20.8	18.0	15.9	14.2	12.8	11.7	10.8
4"dia. STD.	10.79	36	3.17	28	54	35.0	28.9	24.4	21.1	18.6	16.6	15.0	13.7	12.6
TS 4x4x0.1875	9.42	46	2.77	32	58	35.0	32.9	27.8	24.0	21.2	18.9	17.1	15.6	14.4
3.5"dia. X-Strg.	12.50	36	3.68	29	59	35.0	29.3	24.7	21.4	18.8	16.8	15.2	13.9	12.8
TS 4x4x0.2500	12.21	46	3.59	41	75	35.0	35.0	35.0	30.6	27.0	24.1	21.8	19.9	18.3
4"dia. X-Strg.	14.98	36	4.41	38	75	35.0	35.0	33.2	28.7	25.3	22.6	20.5	18.7	17.2
3"dia. XX-Strg.	18.58	36	5.47	33	77	35.0	33.6	28.4	24.5	21.6	19.3	17.5	15.9	14.7
5"dia. STD.	14.62	36	4.30	45	78	35.0	35.0	35.0	33.7	29.7	26.5	24.0	21.9	20.1
TS 4x4x0.3125	14.83	46	4.36	48	90	35.0	35.0	35.0	35.0	31.8	28.4	25.7	23.4	21.6

Column loads are based on a maximum eccentricity of 1" between the resultant (total) load and the centerline of the column.

Supported beams may be single span or continuous with a maximum eccentricity of 1" for the resultant load.

Fy = Minimum design yield stress per the AISC Specification, ksi. K = 1.0

A = Gross cross-sectional area of column per the AISC Manual, in.

Pe = Maximum axial load with an eccentricity of 1", per the AISC Manual, kips.

Pa = Allowable axial load values from the 1989 AISC - ASD Manual, Allowable Concentric Load Tables, kips.

\* No live load reductions have been included.

+ DL is in addition to beam weight & 50plf for the interior walls.

$(C+D)/2$  has been limited to 35 feet to correspond with the beam tables.

Column bearing design must be per the AISC Specification. Guidance on base plate design can be found on pages 3-106 through 3-111 of the 1989 AISC ASD Manual.

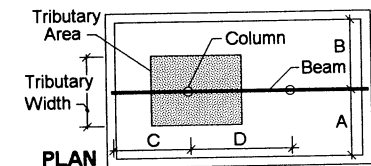
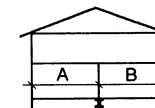



# Steel Beam and Column Tables

Copyright 1993 by American Iron and Steel Institute

<b>Residential Steel Column Load/Spacing Tables - Pipe and Tube Columns</b>			
<b>MAXIMUM COLUMN SPACING, when C = D or MAXIMUM TRIBUTARY LENGTH, (C+D)/2, when C ≠ D; ft.</b>			
<b>TWO FLOORS (no roof or attic loads) - Unbraced Length of Column = 8 feet</b>			
	<b>DL (psf) +</b>	1st flr 15	2nd flr 15
	<b>LL (psf)*</b>	1st flr 40	2nd flr 30

COLUMN SIZE	Column Properties					TRIBUTARY WIDTH SUPPORTED BY THE CENTER BEAM - (A+B)/2								
	Weight/Ft.	Fy	A	Pe	Pa	8'-0	10'-0	12'-0	14'-0	16'-0	18'-0	20'-0	22'-0	24'-0
3"dia. STD.	7.58	36	2.23	16	34	18.0	14.6	12.3	10.7	9.4	8.4	7.6	6.9	6.4
TS 3x3x0.1875	6.87	46	2.02	17	35	19.5	15.9	13.4	11.6	10.2	9.1	8.2	7.5	6.9
3.5"dia. STD.	9.11	36	2.68	22	44	24.7	20.1	17.0	14.7	12.9	11.5	10.4	9.5	8.7
TS 3x3x0.2500	8.81	46	2.59	21	44	24.1	19.6	16.5	14.3	12.6	11.2	10.2	9.3	8.5
3"dia. X-Strg.	10.25	36	3.02	20	45	23.3	19.0	16.0	13.8	12.2	10.9	9.8	9.0	8.2
TS 3x3x0.3125	10.58	46	3.11	24	51	27.5	22.4	18.9	16.3	14.4	12.8	11.6	10.6	9.7
4"dia. STD.	10.79	36	3.17	28	54	32.2	26.2	22.1	19.1	16.8	15.0	13.6	12.4	11.4
TS 4x4x0.1875	9.42	46	2.77	32	58	35.0	29.8	25.2	21.8	19.2	17.1	15.5	14.1	13.0
3.5"dia. X-Strg.	12.50	36	3.68	29	59	32.6	26.5	22.4	19.3	17.0	15.2	13.7	12.5	11.5
TS 4x4x0.2500	12.21	46	3.59	41	75	35.0	35.0	32.0	27.7	24.4	21.8	19.7	17.9	16.5
4"dia. X-Strg.	14.98	36	4.41	38	75	35.0	35.0	30.1	26.0	22.9	20.5	18.5	16.9	15.5
3"dia. XX-Strg.	18.58	36	5.47	33	77	35.0	30.5	25.7	22.2	19.6	17.5	15.8	14.4	13.2
5"dia. STD.	14.62	36	4.30	45	78	35.0	35.0	35.0	30.5	26.8	24.0	21.7	19.8	18.2
TS 4x4x0.3125	14.83	46	4.36	48	90	35.0	35.0	35.0	32.7	28.8	25.7	23.2	21.2	19.5

Column loads are based on a maximum eccentricity of 1" between the resultant (total) load and the centerline of the column.

Supported beams may be single span or continuous with a maximum eccentricity of 1" for the resultant load.

Fy = Minimum design yield stress per the AISC Specification, ksi. K = 1.0

A = Gross cross-sectional area of column per the AISC Manual, in.

Pe = Maximum axial load with an eccentricity of 1", per the AISC Manual, kips.

Pa = Allowable axial load values from the 1989 AISC - ASD Manual, Allowable Concentric Load Tables, kips.

\* No live load reductions have been included. + DL is in addition to beam weight & 50plf for the interior walls.

(C+D)/2 has been limited to 35 feet to correspond with the beam tables.

Column bearing design must be per the AISC Specification. Guidance on base plate design can be found on pages 3-106 through 3-111 of the 1989 AISC ASD Manual.

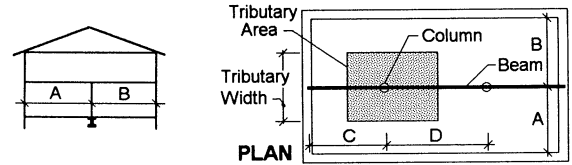



# Steel Beam and Column Tables

Copyright 1993 by American Iron and Steel Institute

**Residential Steel Column Load/Spacing Tables - Pipe and Tube Columns**

**MAXIMUM COLUMN SPACING, when  $C = D$  or MAXIMUM TRIBUTARY LENGTH,  $(C+D)/2$ , when  $C \neq D$ ; ft.**

**TWO FLOORS (no roof or attic loads) - Unbraced Length of Column = 8 feet**

<b>DL (psf) +</b>	1st flr 20	2nd flr 20
<b>LL (psf)*</b>	1st flr 40	2nd flr 30

COLUMN	Column Properties					TRIBUTARY WIDTH SUPPORTED BY THE CENTER BEAM - (A+B)/2									
	SIZE	Weight/Ft.	Fy	A	Pe	Pa	8'-0	10'-0	12'-0	14'-0	16'-0	18'-0	20'-0	22'-0	24'-0
3"dia. STD.	7.58	36	2.23	16	34	16.5	13.4	11.3	9.7	8.6	7.7	6.9	6.3	5.8	
TS 3x3x0.1875	6.87	46	2.02	17	35	17.9	14.5	12.2	10.6	9.3	8.3	7.5	6.8	6.3	
3.5"dia. STD.	9.11	36	2.68	22	44	22.7	18.4	15.5	13.4	11.8	10.5	9.5	8.7	8.0	
TS 3x3x0.2500	8.81	46	2.59	21	44	22.1	17.9	15.1	13.0	11.5	10.3	9.3	8.4	7.8	
3"dia. X-Strg.	10.25	36	3.02	20	45	21.4	17.4	14.6	12.6	11.1	9.9	9.0	8.2	7.5	
TS 3x3x0.3125	10.58	46	3.11	24	51	25.2	20.5	17.2	14.9	13.1	11.7	10.6	9.6	8.9	
4"dia. STD.	10.79	36	3.17	28	54	29.5	24.0	20.2	17.4	15.3	13.7	12.4	11.3	10.4	
TS 4x4x0.1875	9.42	46	2.77	32	58	33.6	27.3	23.0	19.9	17.5	15.6	14.1	12.9	11.8	
3.5"dia. X-Strg.	12.50	36	3.68	29	59	29.9	24.3	20.4	17.7	15.5	13.9	12.5	11.4	10.5	
TS 4x4x0.2500	12.21	46	3.59	41	75	35.0	34.7	29.3	25.3	22.3	19.9	17.9	16.4	15.0	
4"dia. X-Strg.	14.98	36	4.41	38	75	35.0	32.7	27.5	23.8	20.9	18.7	16.9	15.4	14.1	
3"dia. XX-Strg.	18.58	36	5.47	33	77	34.3	27.9	23.5	20.3	17.8	15.9	14.4	13.1	12.1	
5"dia. STD.	14.62	36	4.30	45	78	35.0	35.0	32.2	27.8	24.5	21.9	19.8	18.0	16.6	
TS 4x4x0.3125	14.83	46	4.36	48	90	35.0	35.0	34.5	29.8	26.3	23.4	21.2	19.3	17.7	

Column loads are based on a maximum eccentricity of 1" between the resultant (total) load and the centerline of the column.

Supported beams may be single span or continuous with a maximum eccentricity of 1" for the resultant load.

Fy = Minimum design yield stress per the AISC Specification, ksi. K = 1.0

A = Gross cross-sectional area of column per the AISC Manual, in.

Pe = Maximum axial load with an eccentricity of 1", per the AISC Manual, kips.

Pa = Allowable axial load values from the 1989 AISC - ASD Manual, Allowable Concentric Load Tables, kips.

\* No live load reductions have been included.

+ DL is in addition to beam weight & 50plf for the interior walls.

(C+D)/2 has been limited to 35 feet to correspond with the beam tables.

Column bearing design must be per the AISC Specification. Guidance on base plate design can be found on pages 3-106 through 3-111 of the 1989 AISC ASD Manual.

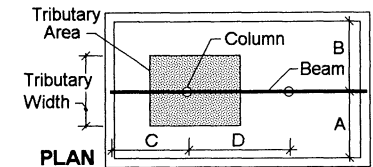
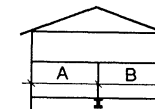





# Steel Beam and Column Tables

Copyright 1993 by American Iron and Steel Institute

<b>Residential Steel Column Load/Spacing Tables - Pipe and Tube Columns</b>			
<b>MAXIMUM COLUMN SPACING, when C = D or MAXIMUM TRIBUTARY LENGTH, (C+D)/2, when C ≠ D; ft.</b>			
<b>THREE FLOORS (no roof or attic loads) - Unbraced Length of Column = 8 feet</b>			
	<b>DL (psf) +</b>	<b>1st flr 10</b>	<b>2 &amp; 3 10</b>
	<b>LL (psf)*</b>	<b>1st flr 40</b>	<b>2 &amp; 3 30</b>

COLUMN SIZE	Column Properties					TRIBUTARY WIDTH SUPPORTED BY THE CENTER BEAM - (A+B)/2									
	Weight/Ft.	Fy	A	Pe	Pa	8'-0	10'-0	12'-0	14'-0	16'-0	18'-0	20'-0	22'-0	24'-0	
3"dia. STD.	7.58	36	2.23	16	34	13.5	11.0	9.3	8.1	7.1	6.4	5.8	5.3	--	
TS 3x3x0.1875	6.87	46	2.02	17	35	14.6	12.0	10.1	8.8	7.7	6.9	6.3	5.7	5.3	
3.5"dia. STD.	9.11	36	2.68	22	44	18.6	15.2	12.8	11.1	9.8	8.8	7.9	7.2	6.7	
TS 3x3x0.2500	8.81	46	2.59	21	44	18.1	14.8	12.5	10.8	9.6	8.5	7.7	7.1	6.5	
3"dia. X-Strg.	10.25	36	3.02	20	45	17.5	14.3	12.1	10.5	9.3	8.3	7.5	6.8	6.3	
TS 3x3x0.3125	10.58	46	3.11	24	51	20.7	16.9	14.3	12.4	10.9	9.8	8.8	8.1	7.4	
4"dia. STD.	10.79	36	3.17	28	54	24.2	19.8	16.7	14.5	12.8	11.4	10.3	9.4	8.7	
TS 4x4x0.1875	9.42	46	2.77	32	58	27.5	22.5	19.0	16.5	14.6	13.0	11.8	10.7	9.9	
3.5"dia. X-Strg.	12.50	36	3.68	29	59	24.5	20.0	16.9	14.7	12.9	11.6	10.5	9.6	8.8	
TS 4x4x0.2500	12.21	46	3.59	41	75	35.0	28.7	24.2	21.0	18.5	16.6	15.0	13.7	12.6	
4"dia. X-Strg.	14.98	36	4.41	38	75	32.9	26.9	22.8	19.7	17.4	15.6	14.1	12.9	11.8	
3"dia. XX-Strg.	18.58	36	5.47	33	77	28.1	23.0	19.4	16.8	14.9	13.3	12.0	11.0	10.1	
5"dia. STD.	14.62	36	4.30	45	78	35.0	31.5	26.7	23.1	20.4	18.2	16.5	15.1	13.9	
TS 4x4x0.3125	14.83	46	4.36	48	90	35.0	33.8	28.6	24.8	21.8	19.5	17.7	16.1	14.8	

Column loads are based on a maximum eccentricity of 1" between the resultant (total) load and the centerline of the column.

Supported beams may be single span or continuous with a maximum eccentricity of 1" for the resultant load.

Fy = Minimum design yield stress per the AISC Specification, ksi. K = 1.0

A = Gross cross-sectional area of column per the AISC Manual, in.

Pe = Maximum axial load with an eccentricity of 1", per the AISC Manual, kips.

Pa = Allowable axial load values from the 1989 AISC - ASD Manual, Allowable Concentric Load Tables, kips.

\* No live load reductions have been included.

+ DL is in addition to beam weight & 100plf for the interior walls.

(C+D)/2 has been limited to 35 feet to correspond with the beam tables.

Column bearing design must be per the AISC Specification. Guidance on base plate design can be found on pages 3-106 through 3-111 of the 1989 AISC ASD Manual.

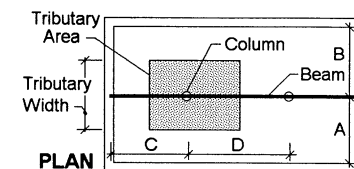
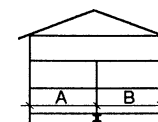



# Steel Beam and Column Tables

Copyright 1993 by American Iron and Steel Institute

<b>Residential Steel Column Load/Spacing Tables - Pipe and Tube Columns</b>						<b>MAXIMUM COLUMN SPACING, when C = D or MAXIMUM TRIBUTARY LENGTH, (C+D)/2, when C ≠ D; ft.</b>											
<b>THREE FLOORS (no roof or attic loads) - Unbraced Length of Column = 8 feet</b>						<b>DL (psf) +</b>		<b>1st flr 15</b>		<b>2 &amp; 3 15</b>		<b>LL (psf)*</b>		<b>1st flr 40</b>		<b>2 &amp; 3 30</b>	
<b>COLUMN</b>	<b>Column Properties</b>					<b>TRIBUTARY WIDTH SUPPORTED BY THE CENTER BEAM - (A+B)/2</b>											
<b>SIZE</b>	<b>Weight/Ft.</b>	<b>Fy</b>	<b>A</b>	<b>Pe</b>	<b>Pa</b>	<b>8'-0"</b>	<b>10'-0"</b>	<b>12'-0"</b>	<b>14'-0"</b>	<b>16'-0"</b>	<b>18'-0"</b>	<b>20'-0"</b>	<b>22'-0"</b>	<b>24'-0"</b>			
<b>3"dia. STD.</b>	7.58	36	2.23	16	34	12.2	10.0	8.4	7.3	6.4	5.7	5.2	--	--			
<b>TS 3x3x0.1875</b>	6.87	46	2.02	17	35	13.3	10.8	9.1	7.9	7.0	6.2	5.6	5.1	--			
<b>3.5"dia. STD.</b>	9.11	36	2.68	22	44	16.8	13.7	11.6	10.0	8.8	7.9	7.2	6.5	6.0			
<b>TS 3x3x0.2500</b>	8.81	46	2.59	21	44	16.4	13.4	11.3	9.8	8.6	7.7	7.0	6.4	5.8			
<b>3"dia. X-Strg.</b>	10.25	36	3.02	20	45	15.9	13.0	10.9	9.5	8.3	7.5	6.7	6.2	5.7			
<b>TS 3x3x0.3125</b>	10.58	46	3.11	24	51	18.7	15.3	12.9	11.2	9.8	8.8	8.0	7.3	6.7			
<b>4"dia. STD.</b>	10.79	36	3.17	28	54	21.9	17.9	15.1	13.1	11.5	10.3	9.3	8.5	7.8			
<b>TS 4x4x0.1875</b>	9.42	46	2.77	32	58	25.0	20.4	17.2	14.9	13.1	11.7	10.6	9.7	8.9			
<b>3.5"dia. X-Strg.</b>	12.50	36	3.68	29	59	22.2	18.1	15.3	13.2	11.7	10.4	9.4	8.6	7.9			
<b>TS 4x4x0.2500</b>	12.21	46	3.59	41	75	31.8	25.9	21.9	18.9	16.7	14.9	13.5	12.3	11.3			
<b>4"dia. X-Strg.</b>	14.98	36	4.41	38	75	29.9	24.4	20.6	17.8	15.7	14.0	12.7	11.6	10.6			
<b>3"dia. XX-Strg.</b>	18.58	36	5.47	33	77	25.5	20.8	17.6	15.2	13.4	12.0	10.8	9.9	9.1			
<b>5"dia. STD.</b>	14.62	36	4.30	45	78	35.0	28.5	24.1	20.9	18.4	16.4	14.9	13.6	12.5			
<b>TS 4x4x0.3125</b>	14.83	46	4.36	48	90	35.0	30.6	25.8	22.4	19.7	17.6	15.9	14.5	13.4			

Column loads are based on a maximum eccentricity of 1" between the resultant (total) load and the centerline of the column.  
 Supported beams may be single span or continuous with a maximum eccentricity of 1" for the resultant load.  
 Fy = Minimum design yield stress per the AISC Specification, ksi. K = 1.0  
 A = Gross cross-sectional area of column per the AISC Manual, in.  
 Pe = Maximum axial load with an eccentricity of 1", per the AISC Manual, kips.  
 Pa = Allowable axial load values from the 1989 AISC - ASD Manual, Allowable Concentric Load Tables, kips.  
 \* No live load reductions have been included. + DL is in addition to beam weight & 100plf for the interior walls.  
 (C+D)/2 has been limited to 35 feet to correspond with the beam tables.  
 Column bearing design must be per the AISC Specification. Guidance on base plate design can be found on pages 3-106 through 3-111 of the 1989 AISC ASD Manual.

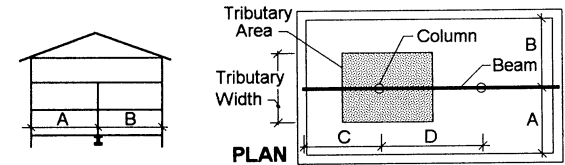



# Steel Beam and Column Tables

Copyright 1993 by American Iron and Steel Institute

## Residential Steel Column Load/Spacing Tables - Pipe and Tube Columns

**MAXIMUM COLUMN SPACING, when C = D or MAXIMUM TRIBUTARY LENGTH, (C+D)/2, when C ≠ D; ft.**  
**THREE FLOORS (no roof or attic loads) - Unbraced Length of Column = 8 feet**

<b>DL (psf) +</b>	<b>1st flr 20</b>	<b>2 &amp; 3 20</b>
<b>LL (psf)*</b>	<b>1st flr 40</b>	<b>2 &amp; 3 30</b>

COLUMN SIZE	Column Properties					TRIBUTARY WIDTH SUPPORTED BY THE CENTER BEAM - (A+B)/2								
	Weight/Ft.	F <sub>y</sub>	A	P <sub>e</sub>	P <sub>a</sub>	8'-0	10'-0	12'-0	14'-0	16'-0	18'-0	20'-0	22'-0	24'-0
3"dia. STD.	7.58	36	2.23	16	34	11.2	9.1	7.7	6.6	5.9	5.2	--	--	--
TS 3x3x0.1875	6.87	46	2.02	17	35	12.1	9.9	8.3	7.2	6.3	5.7	5.1	--	--
3.5"dia. STD.	9.11	36	2.68	22	44	15.4	12.5	10.6	9.1	8.1	7.2	6.5	5.9	5.5
TS 3x3x0.2500	8.81	46	2.59	21	44	15.0	12.2	10.3	8.9	7.8	7.0	6.3	5.8	5.3
3"dia. X-Strg.	10.25	36	3.02	20	45	14.5	11.8	10.0	8.6	7.6	6.8	6.1	5.6	5.1
TS 3x3x0.3125	10.58	46	3.11	24	51	17.1	13.9	11.8	10.2	9.0	8.0	7.2	6.6	6.1
4"dia. STD.	10.79	36	3.17	28	54	20.0	16.3	13.8	11.9	10.5	9.4	8.5	7.7	7.1
TS 4x4x0.1875	9.42	46	2.77	32	58	22.8	18.6	15.7	13.6	12.0	10.7	9.7	8.8	8.1
3.5"dia. X-Strg.	12.50	36	3.68	29	59	20.3	16.5	13.9	12.1	10.6	9.5	8.6	7.8	7.2
TS 4x4x0.2500	12.21	46	3.59	41	75	29.1	23.7	20.0	17.3	15.2	13.6	12.3	11.2	10.3
4"dia. X-Strg.	14.98	36	4.41	38	75	27.3	22.2	18.8	16.2	14.3	12.8	11.5	10.5	9.7
3"dia. XX-Strg.	18.58	36	5.47	33	77	23.3	19.0	16.0	13.8	12.2	10.9	9.8	9.0	8.3
5"dia. STD.	14.62	36	4.30	45	78	32.0	26.1	22.0	19.0	16.7	15.0	13.5	12.3	11.3
TS 4x4x0.3125	14.83	46	4.36	48	90	34.3	27.9	23.6	20.4	17.9	16.0	14.5	13.2	12.1

Column loads are based on a maximum eccentricity of 1" between the resultant (total) load and the centerline of the column.

Supported beams may be single span or continuous with a maximum eccentricity of 1" for the resultant load.

F<sub>y</sub> = Minimum design yield stress per the AISC Specification, ksi. K = 1.0

A = Gross cross-sectional area of column per the AISC Manual, in.

P<sub>e</sub> = Maximum axial load with an eccentricity of 1", per the AISC Manual, kips.

P<sub>a</sub> = Allowable axial load values from the 1989 AISC - ASD Manual, Allowable Concentric Load Tables, kips.

\* No live load reductions have been included.

+ DL is in addition to beam weight & 100plf for the interior walls.

(C+D)/2 has been limited to 35 feet to correspond with the beam tables.

Column bearing design must be per the AISC Specification. Guidance on base plate design can be found on pages 3-106 through 3-111 of the 1989 AISC ASD Manual.

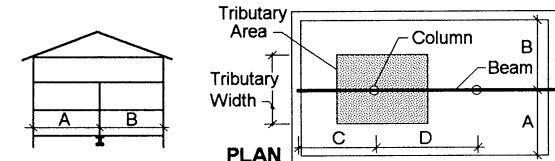

**METRIC CONVERSION TABLE**

<b>Quantity</b>	<b>From Inch-Pound Units</b>	<b>To Metric Units</b>	<b>Multiply by</b>
Length	foot	m	0.304 8
	inch	mm mm	304 8 25 4
Area	square foot	m <sup>2</sup>	0 092 903 04
	square inches	mm <sup>2</sup>	645 16
Force	lb	N	4.448 22
	kip	kN	4 448 22
Force/unit length	plf	N/m	14 593 9
	klf	kN/m	14 593 9
Pressure, stress, modulus of elasticity	psf	Pa	47 880 3
	ksf	kN/m	47.880 3
Bending moment, torque moment of force	ft-lb	N-m	1 355 82
	kt-kip	kN-m	1 355 82
Second moment of area	in <sup>4</sup>	mm <sup>4</sup>	416 231
Section modulus	in <sup>3</sup>	mm <sup>3</sup>	16 387 064

AISI

RG-936

0693-2M-R1

Printed in U.S.A.